



**BULLARD
BOLLARDS**
Think Bollard Think Bullard

TOTEM 40 SOLAR BOLLARD





FIXTURE TYPE: _____

PROJECT NAME: _____



GENERAL INFORMATION:

TOTEM combines a unique design with integrated panels within the structure, striking a perfect balance between elegance and performance. Equipped with SHINGLED PERC solar cells, the solar column can charge under both the sun and cloudy weather, always ensuring an optimal lighting all year long.

NOMINAL FLUX	7840 LUMENS
NOMINAL POWER	40 WATTS

LIGHTING

Efficiency	196 Lumens/Watts
Chips LED	PHILIPS Luxeon 30-30 / 2300K to 6500K
LED lifetime	Over 80 000 hours LM80
Optics/CCT	TII-S / 2300 to 6500K
Light Height	145.67" (3.7m)

BATTERY

Technology	Lithium Iron Phosphate LIFEPO4
Capacity	730Wh
Autonomy	Over 24 hours at full charge - 4 Rainy Days back up
Charging time	6-7 hours
Lifespan	Over 3000 CYCLES @ 80% DOD over 10 years Lifetime
Working temp	14°F to 158°F (optional -40°F to 158°F) -10°C to 70°C (optional -40°C TO 70°C)

ENERGY

Solar panel	195 Watts /18V
Cells type	Monocrystalline Panel Grade A 25 years
Certificates	IEC 61215 - IEC 61730 I and II - IEC 60904

ELECTRONIC

Controller	MPPT SMART CONTROLLER (optional BULLARD SOLAR BRIDGE)
Sensor	Microwave 180° Sensor
Cabling	Waterproof Connector, Plug and Play
Protection	Battery Management System (BMS)

MECHANICAL

Wind speed	160 Km/h
Material	Aluminium and Stainless Steel

DIMENSIONS

Product	145.67" x 12.20" x 14.57" (370 cm x 31 cm x 37 cm)
Carton size	147.64" x 12.99" x 11.02" (375 cm x 33 cm x 280 cm)
Net Weight	103,62 lb (47 KG)
Gross Weight	108,03lb (49 KG)



CERTIFICATIONS IEC / TUV / EMC / LM-79- 08 AND LM-80 TEST STANDARDS / IK8 / IP65 / CE

5 YEARS

* Bullard Solar offers a 5 Year Limited Warranty for the TOTEM-Series luminaire shall be free from defects in material and workmanship for up to five (5) years from date of shipment. This limited warranty covers all components when installed and operated according to Bullard Solar instructions. Fixture suitable for ambient temperature from -10° to 50°. PV Panels - 20 year performance warranty Controller & Batteries : 5 years

THINK BOLLARD - THINK BULLARD

sales@gordonbullard.com
www.bullardbollards.com
1-877-964-4646



991 South Gull Lake Dr
Richland, MI 49083
USA



FIXTURE TYPE: _____

PROJECT NAME: _____

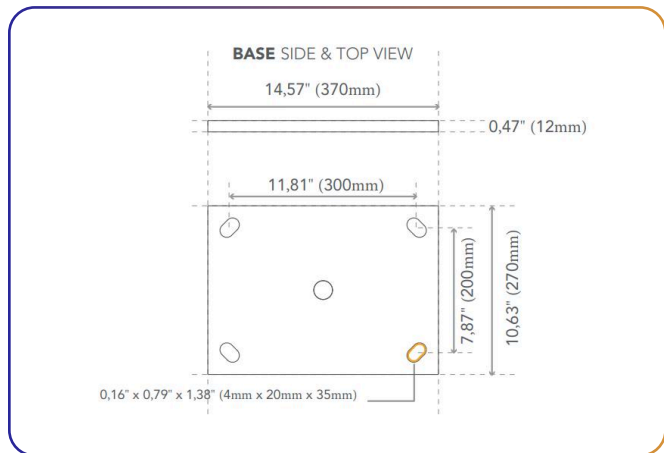
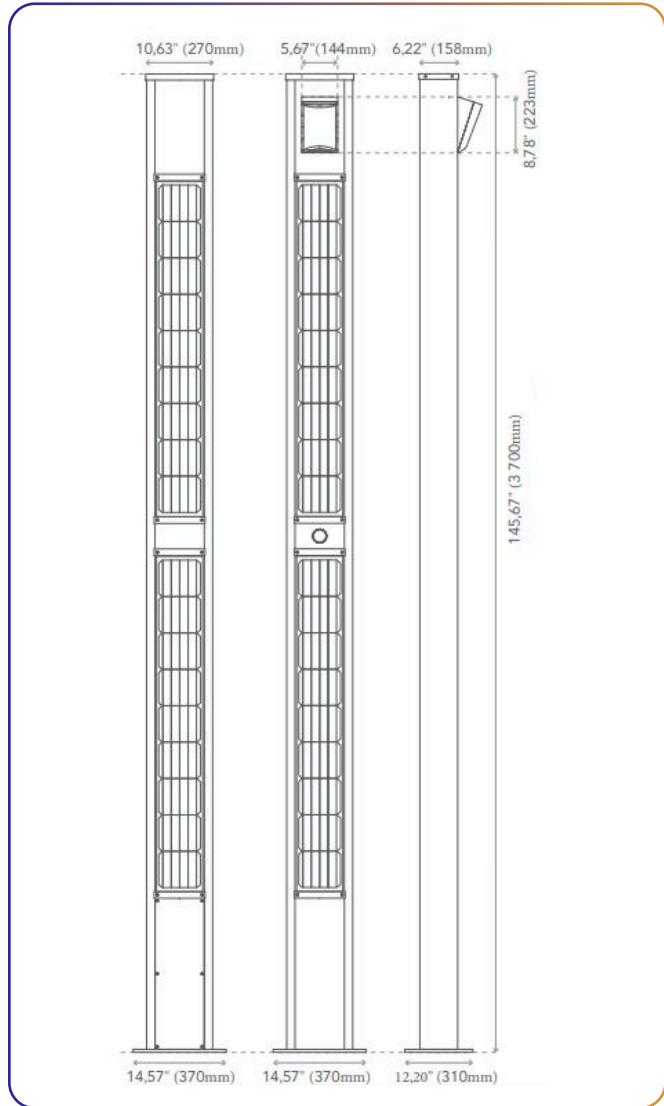

HOW TO ORDER:

CODE:

Example:
CODE: BB-TTM40-BL-23K

**BB-TTM40-
BL-23K**

1 DIMENSIONS:

145.67" x 12.20" x 14.57" (370 cm x 31 cm x 37 cm)

2 FINISH OPTIONS:

-BL Black

3 CCT:

- 23K 2300K
- 30K 3000K
- 40K 4000K
- 50K 5000K
- 65K 6500K

THINK BOLLARD - THINK BULLARD

sales@gordonbullard.com
www.bullardbollards.com
1-877-964-4646



991 South Gull Lake Dr
Richland, MI 49083
USA



**BULLARD
BOLLARDS**
Think Bollard Think Bullard

**CODE:
BB-TTM40**

FIXTURE TYPE: _____
PROJECT NAME: _____

DIMENSIONS *

SOLAR PANEL & BASE

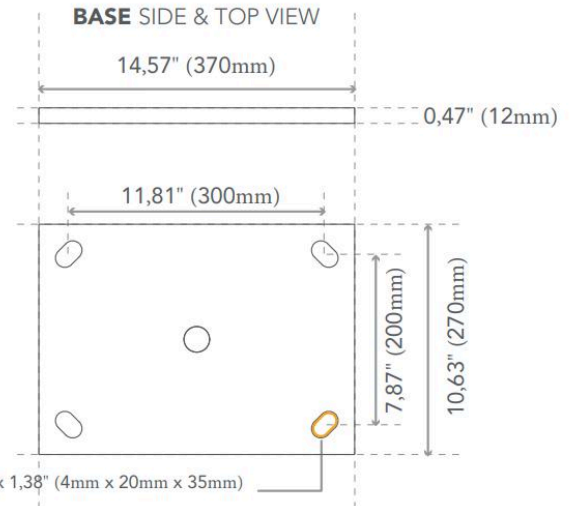
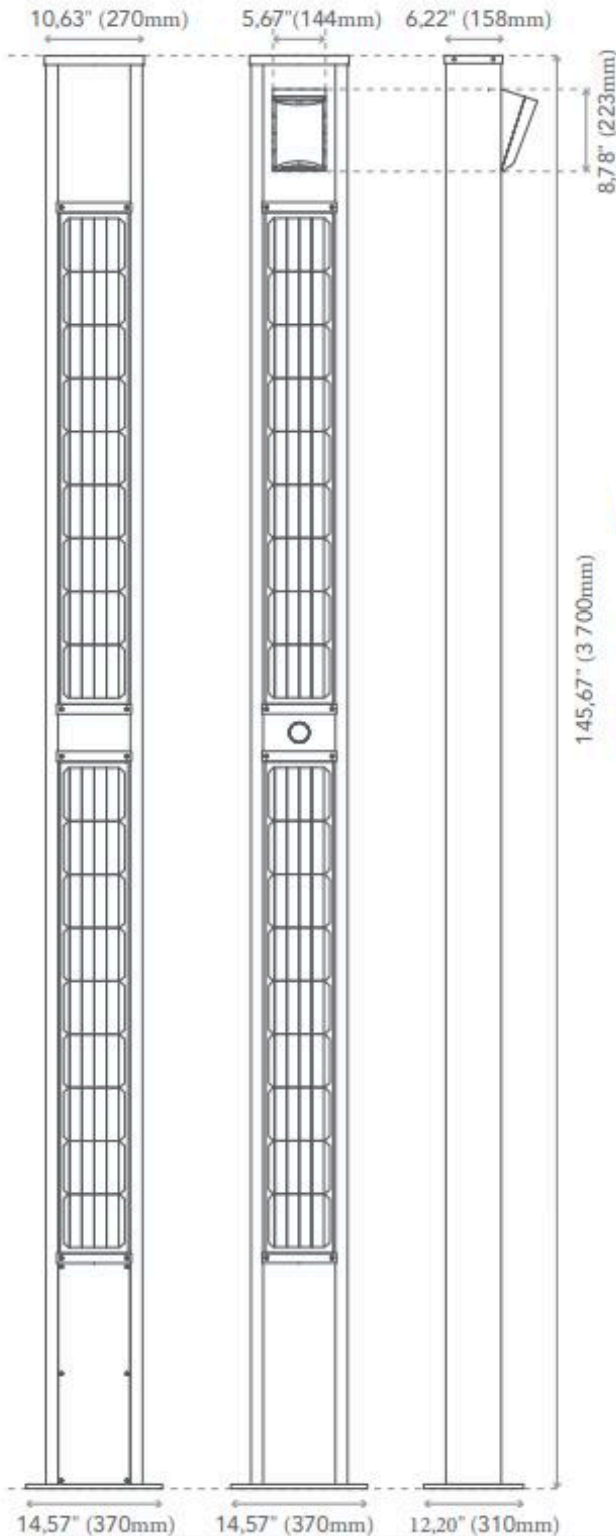

EASY INSTALLATION

NO WIRING NO TRENCH

TOTEM is delivered in a single piece which makes it extremely easy to install. You just need to insert the base onto the anchoring rods previously cast into a concrete foundation.

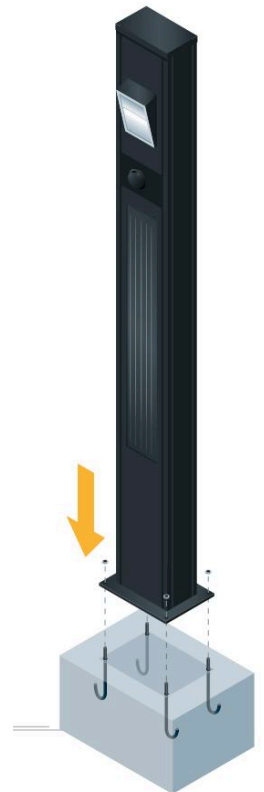

THINK BOLLARD - THINK BULLARD

sales@gordonbullard.com
www.bullardbollards.com
1-877-964-4646



991 South Gull Lake Dr
Richland, MI 49083
USA



**BULLARD
BOLLARDS**
Think Bullard Think Bullard

CODE:
BB-TTM40

FIXTURE TYPE: _____

PROJECT NAME: _____

IP⁶⁵

LUMINAIRE HOUSING & LEDS

7840 LUMENS 2300 TO 6500K

High pressure die-cast low-copper aluminum. Protection class (IP65). BULLARD SOLAR uses a high quality Polyester Powder Coating from AKZO NOBEL. This powder coating provides an excellent salt and humidity resistance as well as ultra violet resistance for color retention for this product. Our Luminaire is equipped with PHILIPS LUXEON HE PLUS High efficiency Chips offering an overall 196 Lumens per Watt efficiency. Our lighting fixture also complies with the current standards regarding light pollution ULR (Upward Light Ratio).



LED	3030	LED QTY (PCS)	72	OPTICS (PCS)	4	CRI	> 70
-----	------	---------------	----	--------------	---	-----	------



SYMMETRICAL DISTRIBUTION

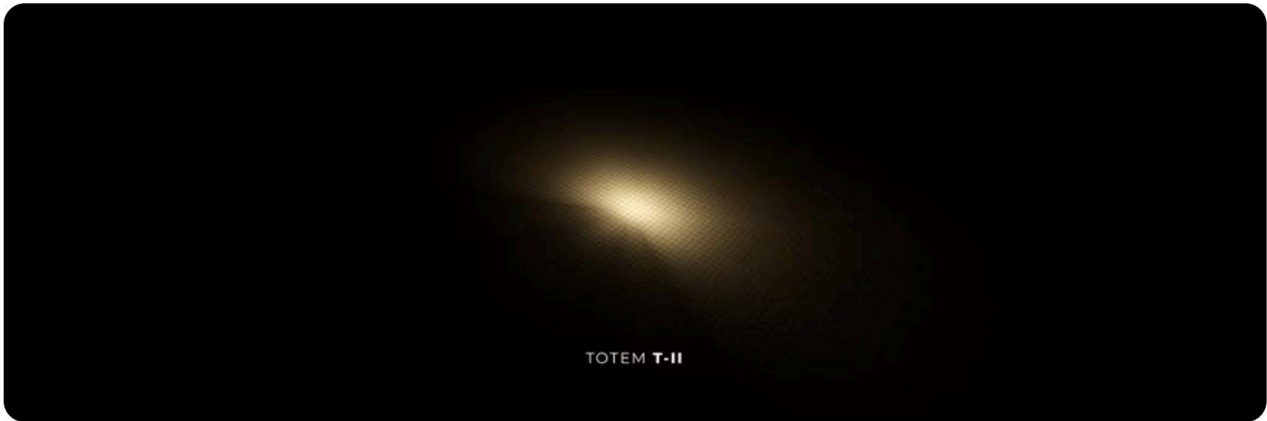

LIGHT DISTRIBUTION CURVES

AVERAGE BEAM ANGLE (50%) : **106,2 DEG**

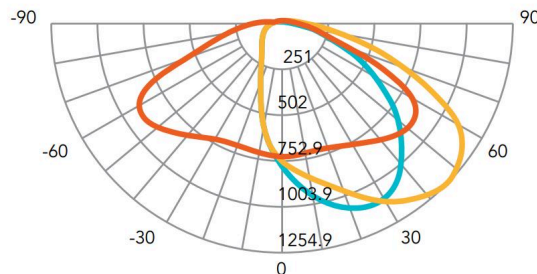

- C0/180,141.3°
- C30/210,122.3°
- C60/240,87.2°

THINK BULLARD - THINK BULLARD

sales@gordonbullard.com

www.bullardbollards.com

1-877-964-4646



991 South Gull Lake Dr

Richland, MI 49083

USA



**BULLARD
BOLLARDS**
Think Bullard Think Bullard

CODE:
BB-TTM40

FIXTURE TYPE: _____

PROJECT NAME: _____

OVER 10 YEARS LIFESPAN

The TOTEM series is equipped with Iron Phosphate Lithium LiFePo4 battery. This technology is proved to be the best chemical technology for solar application on the market. With a cycle life of over 3000 Cycles @ 80% DOD, the battery enjoys lifespan of over 10 years.

EXTREME TEMPERATURE

14°F to 158°F / -10 °C to 70 °C

When Standard Lithium LiFePo4 batteries enjoy a working temperature range from 14°F to 158°F (-10°C TO 70 °C). Bollard Sollar offers as optional a new Special LIFEPO4 battery with working range of -40°F to 158°F (-40 °C. to 70 °C).

EASY MAINTENANCE & ANTI THEFT SCREWS

Easy and direct access to the battery casing for maintenance. The fixation are made with anti theft screws, which request special tooling to unscrew.

**BMS ELECTRONIC PROTECTION
BATTERY MANAGEMENT SYSTEM**

Our batteries are equipped with electronic circuit boards for a higher protection, ensuring battery functioning optimization no matter the situation.

THE BMS PROTECTS AGAINST

- OVER/UNDER CURRENT • OVERLOAD • OVER/UNDER VOLTAGE
- OVER/UNDER CHARGE • TEMPERATURE MANAGEMENT

BATTERY LIFEPO4

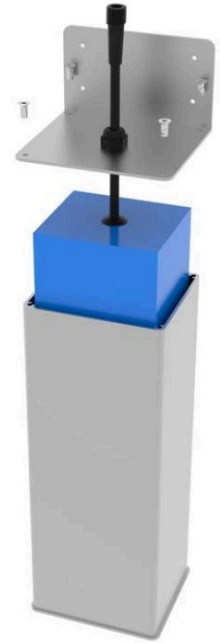

ALUMINUM BOX

High temperatures greatly affect the lifespan of batteries. To solve this problem, our batteries are placed in a sealed extruded aluminum box, which is known for its heat dissipation properties

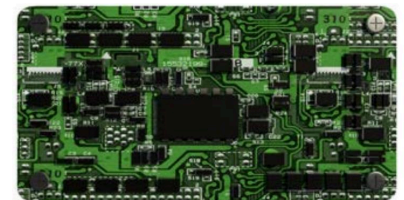

COMPARISONS OF DIFFERENT BATTERY TECHNOLOGIES

LIFETIME & CYCLES AT 80% DOD*
Comparison of different battery technologies



Lead Acid
200



NimH
700



Lithium ION
800



Lithium LifePO4
3 000

**CHARGING TEMPERATURE RANGE
WITHOUT CAPACITY LOSS**
*Minimum & Maximum temperature range for
Optimal charging during the day*

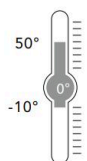

Lead Acid

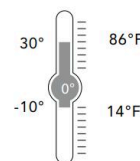

NimH

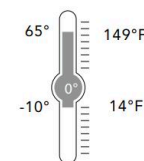

Lithium ION

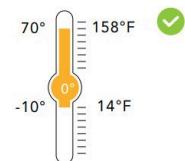

Lithium LifePO4

THINK BOLLARD - THINK BULLARD

sales@gordonbullard.com

www.bullardbollards.com

1-877-964-4646



991 South Gull Lake Dr

Richland, MI 49083

USA



**BULLARD
BOLLARDS**
Think Bullard Think Bullard

**CODE:
BB-TTM40**

FIXTURE TYPE: _____

PROJECT NAME: _____

SOLAR PANEL

115 WATTS

For high performance and a sleek design, the TOTEM lights are equipped with SHINGLED PERC photovoltaic technology, providing very high efficiency, as well as improved performance in low irradiation. It allows maximizing the installed power in a limited space.

SHINGLED PERC ADVANTAGES POWER LOSS DUE TO SHADING



DISCRETION

With no visible connections or circuits, TOTEM is fully integrated into its environment and most people will not notice the presence of solar panels.

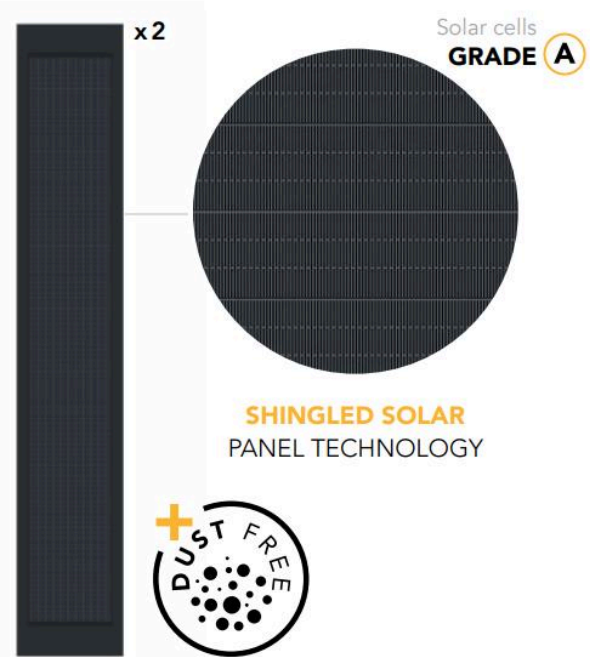

CONTROLLER MPPT



**WATERPROOF CONNECTORS
"PLUG & PLAY"**

All our components are assembled **seamless and easy to access**

In a search for performance and reliability, our products are equipped with MPPT technology controller offering the best charging efficiency on the market up to 98%

REMOTE CONTROL MONITORING

In order to facilitate all maintenance operations and above all to diagnose any possible problem, without having to intervene mechanically on the luminaire, BULLARD SOLAR luminaires are equipped with a wireless diagnostic system via remote control



With a simple click it is possible to have real-time information such as:

- Automatic diagnosis in case of malfunction
- State of charge and battery history
- Real Time load and solar panel energy production history
- Age of the product and installation Temperature and its history

FEATURES

- Minimal stand-by power consumption
- Current consumption ≤ 10mA
- Intelligent battery management

3 Phases charging:

- Charge MPPTT
- Constant voltage
- Floating voltage

- Intelligent LED driver Auto detecting of Dusk and Dawn for automatic operation, 7 Lighting Programs Configuration.
- ANTI BLACK OUT: Load adjust according to battery capacity assuring all night long lighting in any weather conditions.
- The controller also acts against:

- OVERLOAD
- OVERCURREN
- OVERTEMPERATURE
- OVERVOLTAGE / OVERLOAD
- OVERDISCHARGE

THINK BOLLARD - THINK BULLARD

sales@gordonbullard.com

www.bullardbollards.com

1-877-964-4646



991 South Gull Lake Dr

Richland, MI 49083

USA

FIXTURE TYPE: _____

PROJECT NAME: _____

MOTION SENSOR MICROWAVE

Bullard Solar luminaires are equipped with microwave detectors. The microwave detectors that use the Doppler effect (like car radars) to detect nearby objects and measure the distance. The sensor emits a high frequency wave to reflect off of and analyze the objects in the vicinity. Since the microwaves only detect specific objects, detection reliability increases resulting in:

- Much better reliability compared to the Infrared detector
- Up to 180° Directivity
- Insensitivity to other environmental variations such as light, color, temperature, etc.

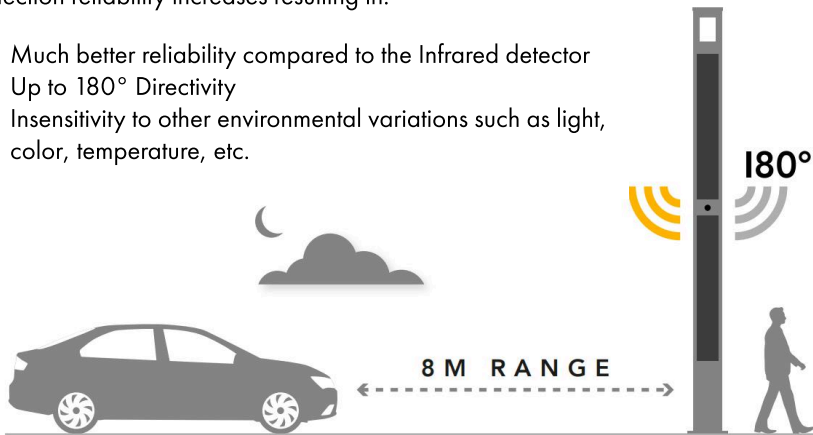

OPERATION MODE & LIGHTING SCHEDULE

In addition to automatic switching on and off, you have the possibility of choosing among different modular operating modes according to the needs of the project.

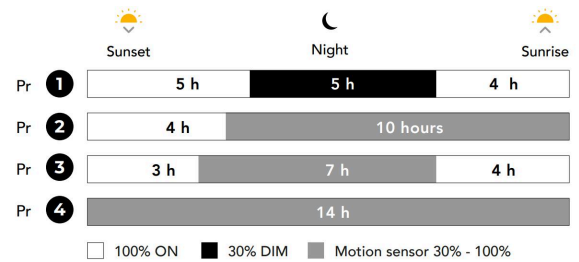

CONTACT US FOR MORE PROGRAM OPTIONS

BULLARD SOLAR BRIDGE REMOTE MONITORING

As part of his continuous effort for development, the Bullard Solar team is proud to have developed a special tool for remote monitoring of our solar street light. Bullard Solar Bridge uses low frequency technology LORA or ZIGBEE to monitor in real time a batch of solar street lights. YOU CAN NOW MANAGE YOUR SOLAR PARK REMOTELY:

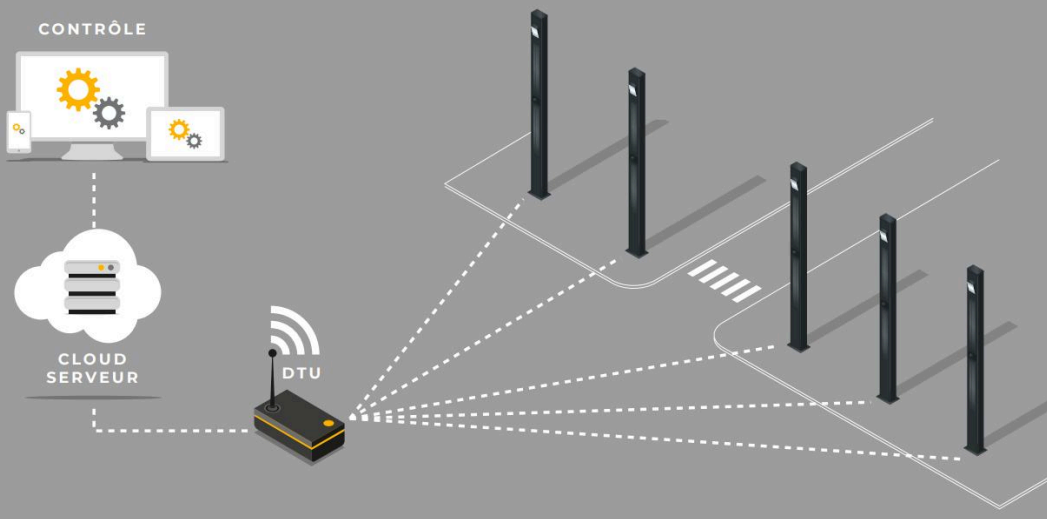

- INTERNET 2G/3G/4G
- CONNEXION SÉCURISÉE
- GRANDE PORTÉE DE COMMUNICATION
- BASSE CONSOMMATION

THINK BOLLARD - THINK BULLARD

sales@gordonbullard.com

www.bullardbollards.com

1-877-964-4646



991 South Gull Lake Dr

Richland, MI 49083

USA