



**BULLARD  
BOLLARDS**  
Think Bollard Think Bullard

# INSTALLATION INSTRUCTION

# BUNNY PURE 4L

INSTALLATION TYPE:  
INGROUND LUMINAIRES



Recessed  
 Assembling instruction  
 For technical information refer to the label on the device

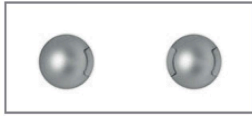

Rough-in compatible with led driver

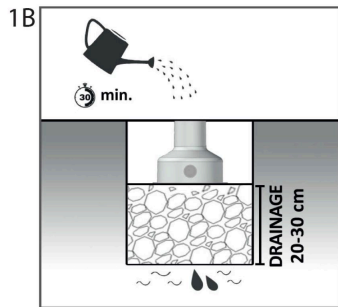

If water does not disappear in 30 min. you must use a further drainage system:

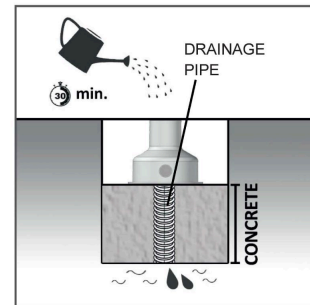
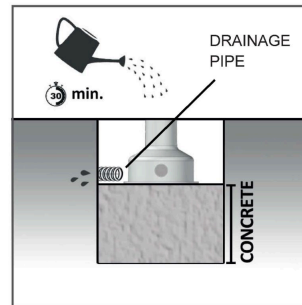

FURTHER DRAINAGE SYSTEM

Hole diameter

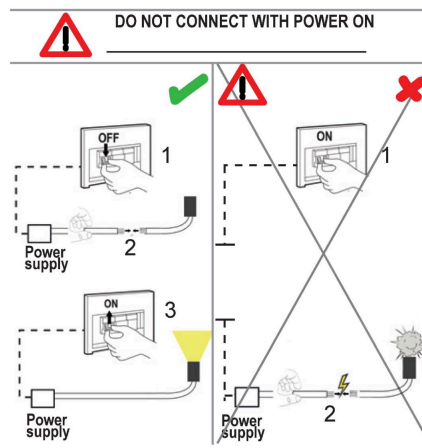
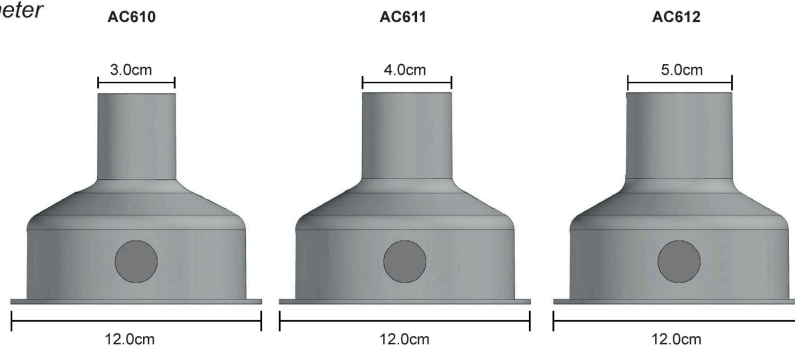

**ROUGH-IN COMPATIBLE WITH LED DRIVER VERSION**

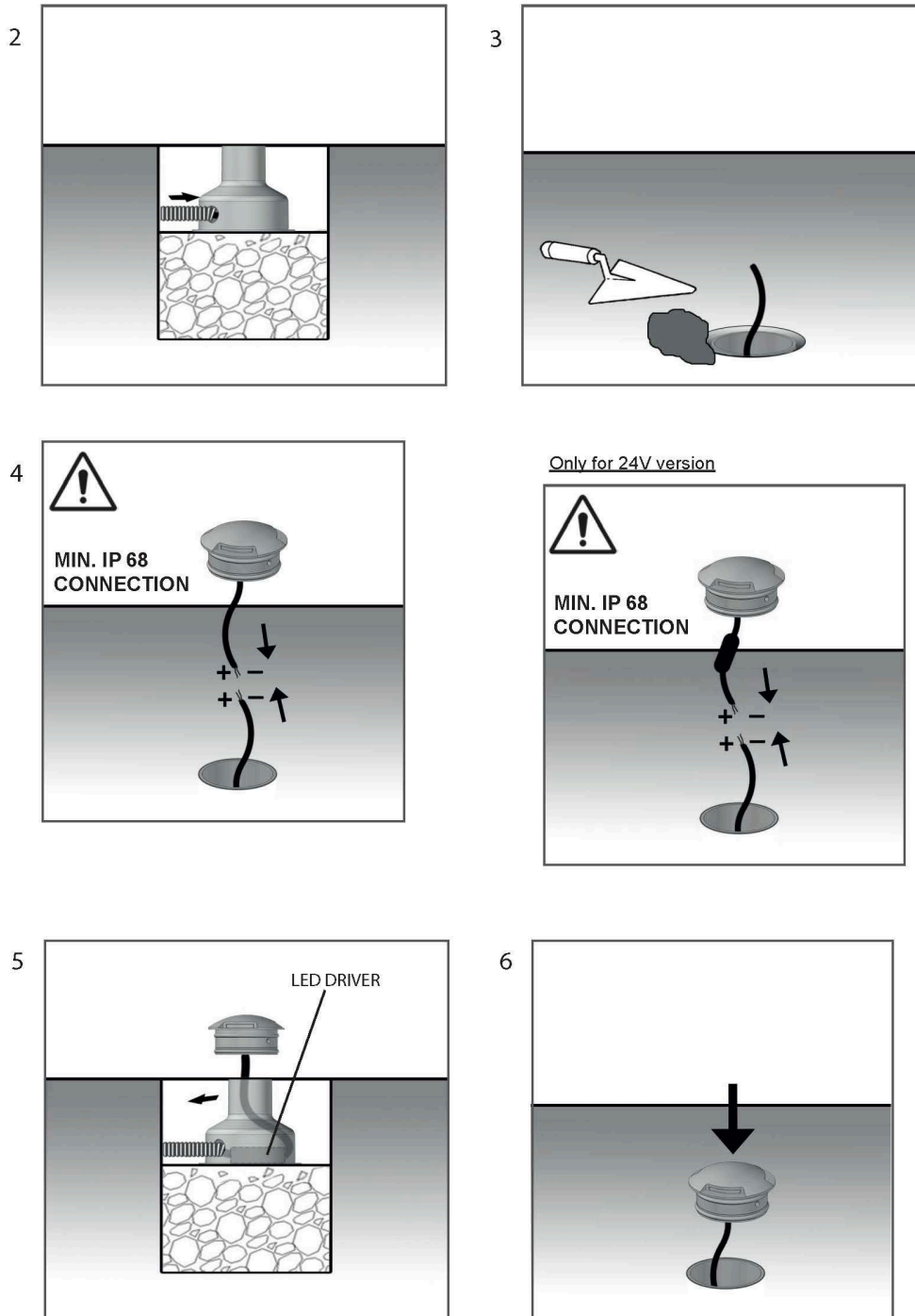

*Connection in series:  
Constant current*

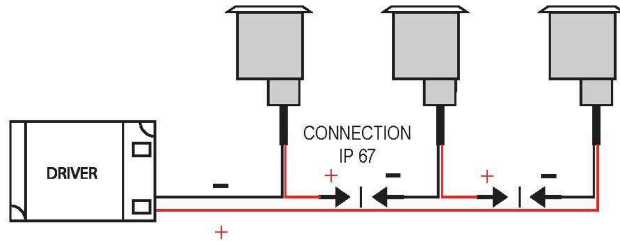

*Connection in parallel:  
Constant voltage - 24 V*

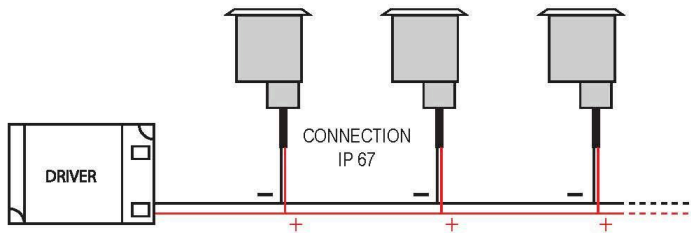

For more information on cable size and driver compatibility, please contact Bullard Bollards customer service.  
For more information on the aluminaire consult the technical data sheet

**IMPORTANT**

- To ensure equipment safety you must carefully follow the instructions below. This leaflet must be kept handy by personnel entrusted with all ordinary and extraordinary maintenance.
- Before any installation or maintenance operation on the bulb, make sure it is disconnected from power.
- Fit the correct bulbs, according to the type and power indicated on the lamp data label.
- Make sure the lamp technical features are compatible with the use you are going to make of it.
- Should you have any doubt, refer to the dealer or ask an electrician.
- When connecting to the mains, follow the correct colour code for power cables: (N) blue, (L) brown or black and, only for class I equipment, (T) yellow/green.
- When lamps are to be fitted to the wall directly through their ceramic parts, fasten the fixing screws lightly, to avoid breaking the ceramic.
- To clean the lamp on the outside, use a soft cloth, possibly wet. Do not use solvents or abrasive products. No liquid must get in contact with the lamp interior parts.
- Do not touch the equipment with dirty hands.



= Class I equipment, must be connected to an earth terminal.



= Double insulated lamp, does not need earthing.



= Electrical equipment in class III, electrical safety guaranteed by low voltage tension, does not require grounding



= Minimum distance to be observed from all lit up objects.



= Replace immediately the safety glass, if damaged, with the original part.



= The lamp uses low pressure bulbs, and needs no protection glass.