

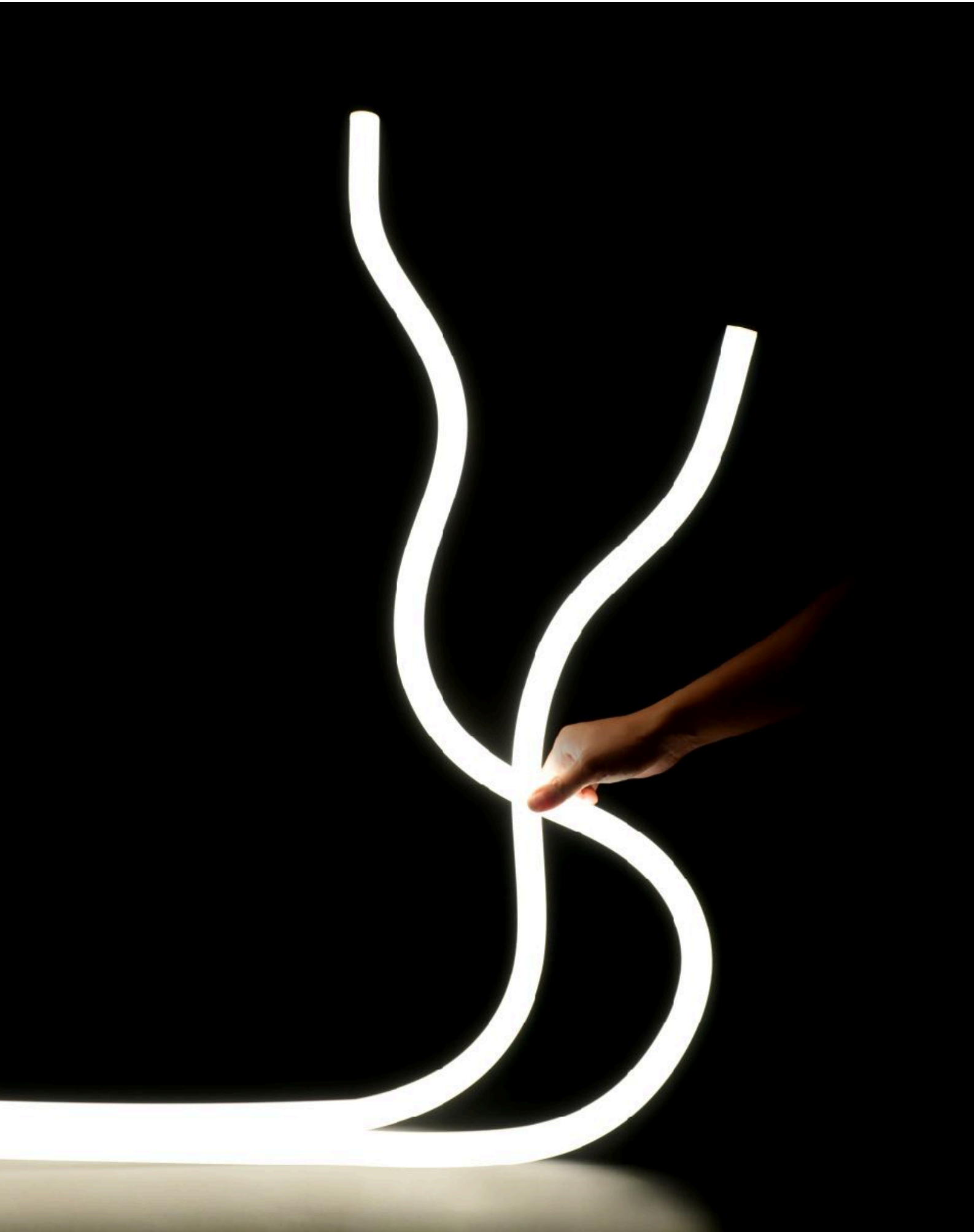

**BULLARD
BOLLARDS**
Think Bollard Think Bullard

FLEX FORM 360 R25 P
BB-FLXF360R25P-CL





FIXTURE TYPE: _____

PROJECT NAME: _____



GENERAL INFORMATION:

The FLEX 360 FORM Collection is a premium round-profile LED neon flex delivering true 360° omnidirectional illumination with integrated shape-retention capability. Engineered with advanced silicone extrusion technology and an internal support structure, it can be bent and formed while maintaining the desired shape without continuous mounting supports. The seamless silicone housing ensures smooth, dot-free illumination with consistent brightness from every viewing angle. This pose-able design allows the creation of suspended forms, curves, and three-dimensional lighting features for architectural and decorative applications. Designed for both indoor and outdoor use, the FLEX 360 FORM series features durable, UV-resistant silicone housing with high ingress protection ratings for long-term reliability. Available in multiple diameters and white light color temperatures, including 2300K, 2700K, 3000K, and 4000K. The system is supplied in fixed lengths with no field cutting allowed, ensuring consistent electrical performance, and is compatible with standard LED drivers.

FIXTURE TYPE:

360 LED Neon Flexible with integrated shape-retention capability

MATERIAL:

High Purity Silica Gel

IP RATING:

IP65

IP65

IK RATING:

IK08

IK08

WARRANTY:

LED lighting products are warranted for 5 years.

DRIVER POSITION:

Remote

MAIN FEATURES:

Functional and minimalistic design
Skin-friendly surface treatment
Operating Temperature: -13°F to +131°F.

THINK BOLLARD - THINK BULLARD

sales@gordonbullard.com
www.bullardbollards.com
1-877-964-4646



991 South Gull Lake Dr
Richland, MI 49083
USA



FIXTURE TYPE: _____

PROJECT NAME: _____

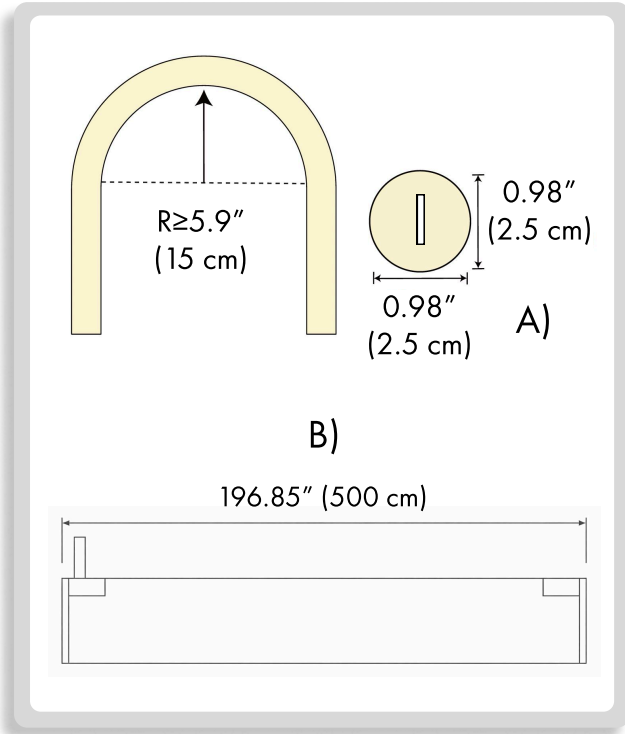

HOW TO ORDER:

CODE:

Example:
CODE: BB-FLXF360R25P-CL-LS1-ECT-AS-
NNR25P1-25-402-02-000000-00013

BB-FLXF360R25P-
CL-LS1-ECT-AS-
NNR25P1-25-402-
02-000000-00013

1 DIMENSIONS:

A) Diameter - Ø: 0.98" (2.5 cm)
B) Length - L: 196.85" (500 cm)

2 LIGHT SOURCE:

CODE	INPUT VOLTAGE	CCT	RATED POWER	CRI	LUMENS	CUTTING
-LS1	24VDC	2300 K	20W (6.08W/ft)	90	920 (280/ft)	No cutting 1.16"
-LS2		2700 K			1100 (335/ft)	
-LS3		3000 K			1180 (359/ft)	
-LS4		4000 K			1140 (347/ft)	
-LSS1	48VDC	2300 K			760 (231/ft)	No cutting 1.31"
-LSS2		2700 K			930 (283/ft)	
-LSS3		3000 K			1000 (304/ft)	
-LSS4		4000 K			960 (292/ft)	

3 ENTRY CABLE:

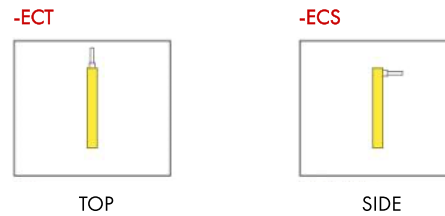

4 ACCESSORIES:

-AS-NNR25P1-25
R25 ceiling fixed installation components

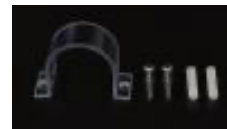

-AS-NNR25VCC1-XX-2
Double-ended vertical ceiling
Kits

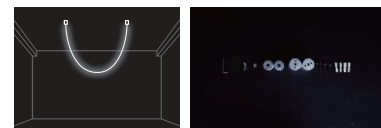

THINK BOLLARD - THINK BULLARD

sales@gordonbullard.com
www.bullardbollards.com
1-877-964-4646



991 South Gull Lake Dr
Richland, MI 49083
USA

FIXTURE TYPE: _____

PROJECT NAME: _____

HOW TO ORDER:

CODE:

Example:
CODE: BB-FLXF360R25P-CL-LS1-ECT-AS-
NNR25P1-25-402-02-000000-00013

BB-FLXF360R25P-
CL-LS1-ECT-AS-
NNR25P1-25-402-
02-000000-00013

4 ACCESSORIES:

-AS-NNR25DHS-XX

Can be spliced
Install components

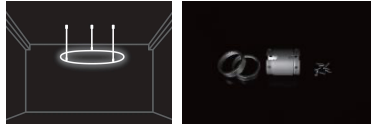

-AS-NNR25DHX-0038

Can be shaped and hoisted
Install components

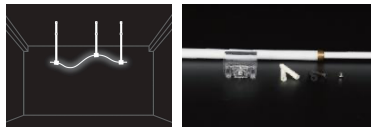

-AS-NNR25LHX-0038

Horizontal hoisting
Install components (38mm)



AS-NNR25DHX-0080

Tail splicing piece (80mm) L: 0.6m



AS-NNR25LHX-0080

Tail splicing piece (80mm) L: 2m



-AS-NNR25VTD-XX-2

R25 Trimless embedded accessory



-AS-NNR25VRD-XX-2

R25 Embedded accessory



-AS-NNR25LHS-0080

R25 No dark areas accessory

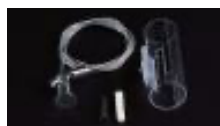

-AS-NNR25GH0-EC

R25 Hole Diameter 4.5mm top cap



-AS-NNR25GS0-EC

R25 Hole Diameter 4.5mm side cap



5 SYSTEM CONTROL:

-402-02-000000-00001

Monochrome Remote Control
R6-1
Operating voltage: 3VDC(Battery CR2032)
Operating frequency: 2.4GHz
Remote control distance: 30m
Operating temperature: -30°C-55°C
Size:L107*W58.5*H9(mm)



-402-02-000000-00013

Monochrome Control Receiver
CR1-GBA
Input voltage: 12-48VDC
Maximum load current: 15A* 1CH, Max15A@12/24V
10A * 1CH, Max10A@36/48V
Maximum load power: 15A* 1CH, Max15A@12/24V
10A * 1CH, Max10A@36/48V
Operating temperature: -30°C-55°C
Size: L175*W45*H27(mm)



THINK BOLLARD - THINK BULLARD

sales@gordonbullard.com
www.bullardbollards.com
1-877-964-4646



991 South Gull Lake Dr
Richland, MI 49083
USA



**BULLARD
BOLLARDS**
Think Bullard Think Bullard

**CODE:
BB-FLXF360R25P-CL**

FIXTURE TYPE: _____

PROJECT NAME: _____

HOW TO ORDER:

CODE:

Example:
CODE: BB-FLXF360R25P-CL-LS1-ECT-AS-
NNR25P1-25-402-02-000000-00013

BB-FLXF360R25P-
CL-LS1-ECT-AS-
NNR25P1-25-402-
02-000000-00013

5 SYSTEM CONTROL:

-402-0-000000-00013

Knob panel controller used for dimming to warm
CP1-GBB



Input voltage: 12-24VDC
Input current: 6A* 1CH
Operating temperature: -30°C-55°C
Size: L86*W86*H33(mm)

THINK BOLLARD - THINK BULLARD

sales@gordonbullard.com
www.bullardbollards.com
1-877-964-4646



991 South Gull Lake Dr
Richland, MI 49083
USA