



**BULLARD
BOLLARDS**
Think Bollard Think Bullard

EYELIGHT FLAT COLLECTION (SURFACE MOUNTED WALL LUMINAIRES)



FIXTURE TYPE: _____

PROJECT NAME: _____

NOTES:

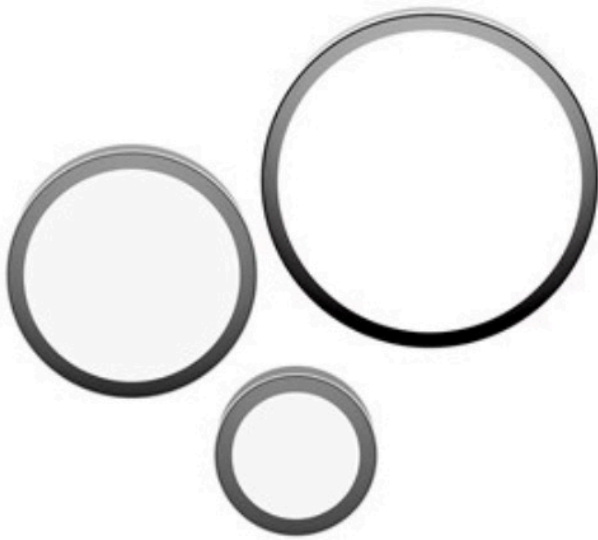

GENERAL INFORMATION:

The Eyclight Flat Collection by Bullard Bollards is a compact outdoor wall light designed to provide subtle, directional illumination for architectural spaces. Its sleek, low-profile form integrates seamlessly into modern exteriors while enhancing safety along stairs, pathways, and terraces. Built from durable materials, it is engineered to withstand outdoor conditions while maintaining a refined appearance. The soft, controlled light output creates a welcoming atmosphere without overwhelming the surrounding environment.

FIXTURE TYPE:

Surface Mounted Wall Luminaires

LIGHTING:

LED

INPUT VOLTAGE:

110-277V

MATERIAL:

Extruded aluminum EN AW-6060 T5 high resistance to oxidation

GASKETS:

Silicone gaskets

EXTERNAL SCREWS:

Stainless steel A4-70 treated with highly antioxidant water-repellent lubricating solution

FINISH AND PROTECTION:

Primary treatment with nanoceramic conversion. Protection with textured polyester powder coating resistant to weathering and UV rays

DRIVER POSITION:

Integral

CRI:

>90

IP RATING:

IP66

APPLINCE CLASS:

I

THINK BOLLARD - THINK BULLARD

sales@gordonbullard.com

www.bullardbollards.com

1-877-964-4646



991 South Gull Lake Dr

Richland, MI 49083

USA

FIXTURE TYPE: _____

PROJECT NAME: _____

NOTES:

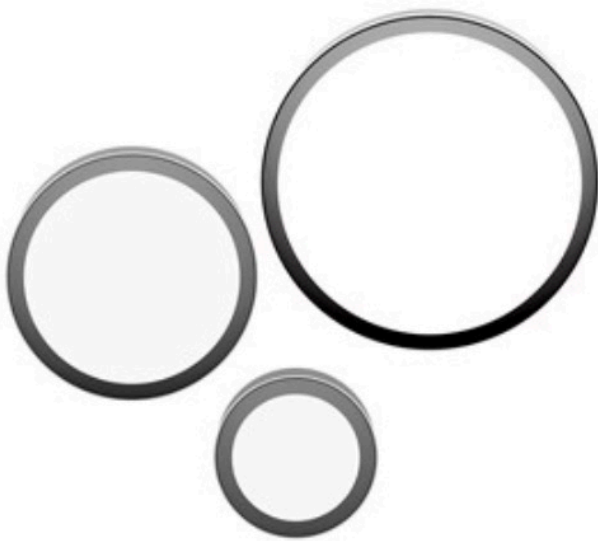

CONTROL:

Dim IGBT-TRIAC

CABLE ENTRY:

Brass cable gland M12 Ø 0.35/0.7 cm

CABLE TYPE:

H05RN-F 3x0.01 cm²

CORD LENGTH:

50cm

BEAM ANGLE / LIGHT DISTRIBUTION:

-100	114°	Symmetrical wide beam (45 ° - 125 °)
-140	114°	Symmetrical wide beam (45 ° - 125 °)
-190	114°	Symmetrical wide beam (45 ° - 125 °)

BEAM DIRECTIONABILITY:

Fixed optics

DIFFUSER MATERIAL/FINISH:

Tempered glass 0.5cm / Opal

WARRANTY:

LED lighting products are warranted for 5 years.

MAIN FEATURES:

- High visual comfort
- Wide range of finishes
- Functional design
- Minimal design
- Reduced overhang
- Operating Temperature: 253.15 K ÷ 308.15 K (-20 °C ÷ +35 °C)
- Increased temperature to 323.15 K (50°C)
- * upon request previous specific components and test



THINK BOLLARD - THINK BULLARD

sales@gordonbullard.com
www.bullardbollards.com
1-877-964-4646



991 South Gull Lake Dr
Richland, MI 49083
USA

FIXTURE TYPE: _____

PROJECT NAME: _____

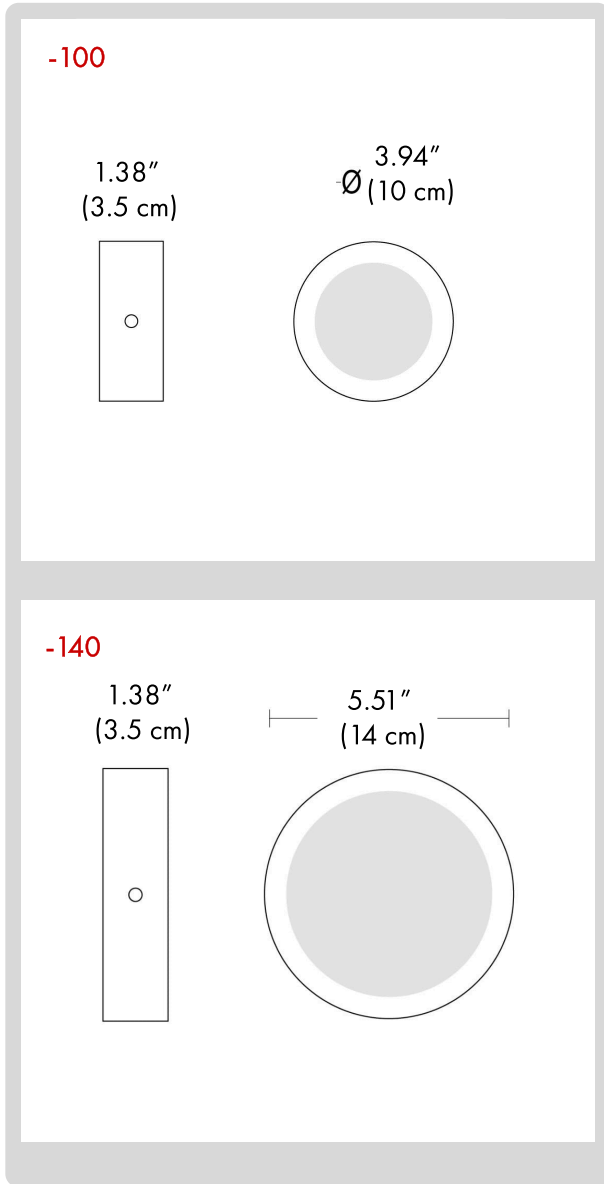

HOW TO ORDER:

CODE:

Example:
CODE: BB-1385.00CAXW-GH-100-K30-DIM-02-AC502

BB-1385.00CAXW-GH
-100-K30-DIM-02
-AC502

1 MODELS:

-100

DIMENSIONS:

Diameter - Ø: 3.94" (10 cm)
Width - W: 1.38" (3.5 cm)

LIGHT SOURCE:

LED / 1 x 7W / 110-277 V / 60 Hz

CCT&LUMENS:

-K30 3000K = 850 lm
-K40 4000K = 900 lm

BEAM ANGLE:

114°

-140

DIMENSIONS:

Diameter - Ø: 5.51" (14 cm)
Width - W: 1.38" (3.5 cm)

LIGHT SOURCE:

LED / 1 x 12W / 110-277 V / 60 Hz

CCT&LUMENS:

-K30 3000K = 1300 lm
-K40 4000K = 1400 lm

BEAM ANGLE:

114°



THINK BOLLARD - THINK BULLARD

sales@gordonbullard.com
www.bullardbollards.com
1-877-964-4646



991 South Gull Lake Dr
Richland, MI 49083
USA



FIXTURE TYPE: _____

PROJECT NAME: _____

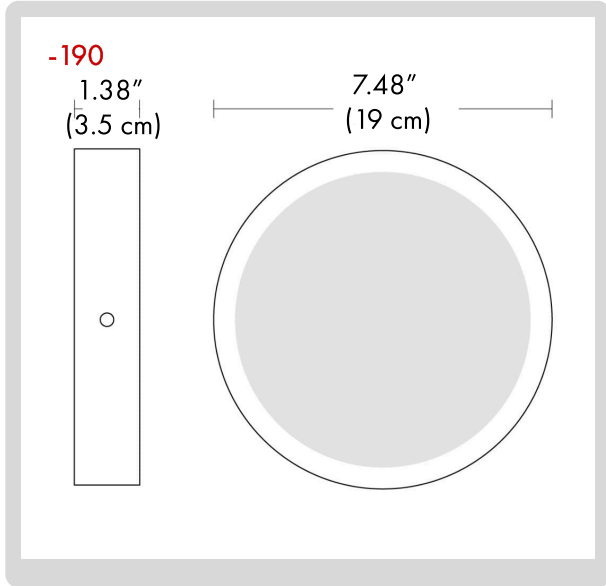

HOW TO ORDER:

CODE:

Example:
CODE: BB-1385.00CAXW-GH-100-K30-DIM-02-AC502

BB-1385.00CAXW-GH
-100-K30-DIM
-02-AC502

1 MODELS:

-190

DIMENSIONS:

Diameter - Ø: 7.48" (19 cm)
Width - W: 1.38" (3.5 cm)

LIGHT SOURCE:

LED / 1 x 15W / 110-277 V / 60 Hz

CCT&LUMENS:

-K30 3000K = 1800 lm

-K40 4000K = 1900 lm

BEAM ANGLE:

114°

2 DIMMING OPTIONS:

-NON NON-Dimmable

-DIM 0-10V

-CAS Casambi

-DAL Dali

3 FINISH OPTIONS:

-01 White matt

-02 Black matt

-05 Anthracite grey matt

-19 Light grey matt

-26 Bronze

-45 Corten matt

-62 Antique grey matt

-65 Blue matt

-80 Sand matt

-83 Green matt



THINK BOLLARD - THINK BULLARD

sales@gordonbullard.com

www.bullardbollards.com

1-877-964-4646



991 South Gull Lake Dr

Richland, MI 49083

USA

HOW TO ORDER:

Example:
CODE: BB-1385.00CAXW-GH-100-K30-DIM-02-AC502

CODE:

BB-1385.00CAXW-GH
-100-K30-DIM
-02-AC502

4 ACCESSORIES:

For model 100:

-AC502

Rough-in housing 502



For model 140/190:

-AC503

Wall recessed rough-in housing 503



5 PHOTOMETRY:

-100

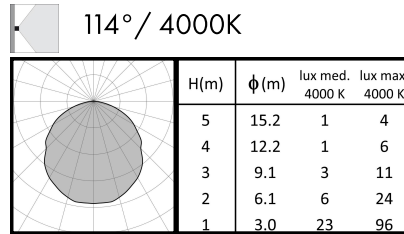
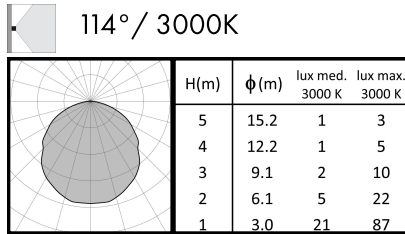

-140

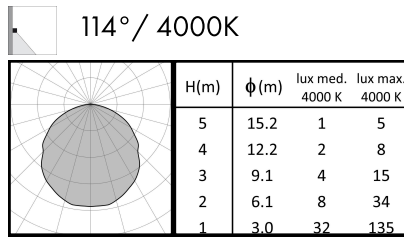
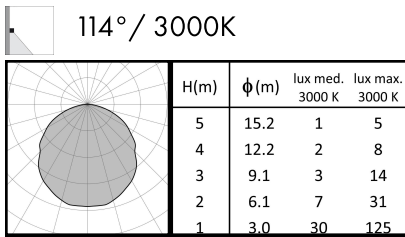

-190

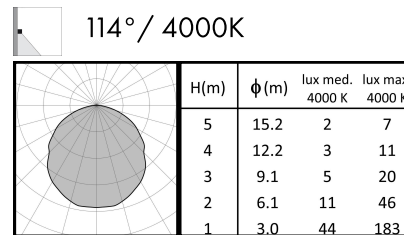
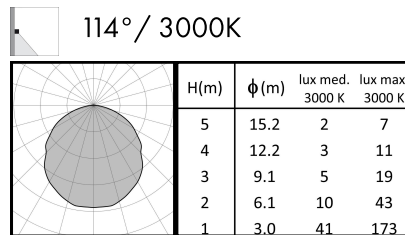

THINK BOLLARD - THINK BULLARD

sales@gordonbullard.com

www.bullardbollards.com

1-877-964-4646



991 South Gull Lake Dr

Richland, MI 49083

USA