



**BULLARD
BOLLARDS**
Think Bollard Think Bullard

FLEX 360 R25
BB-FLX360R25-CL





FIXTURE TYPE: _____

PROJECT NAME: _____

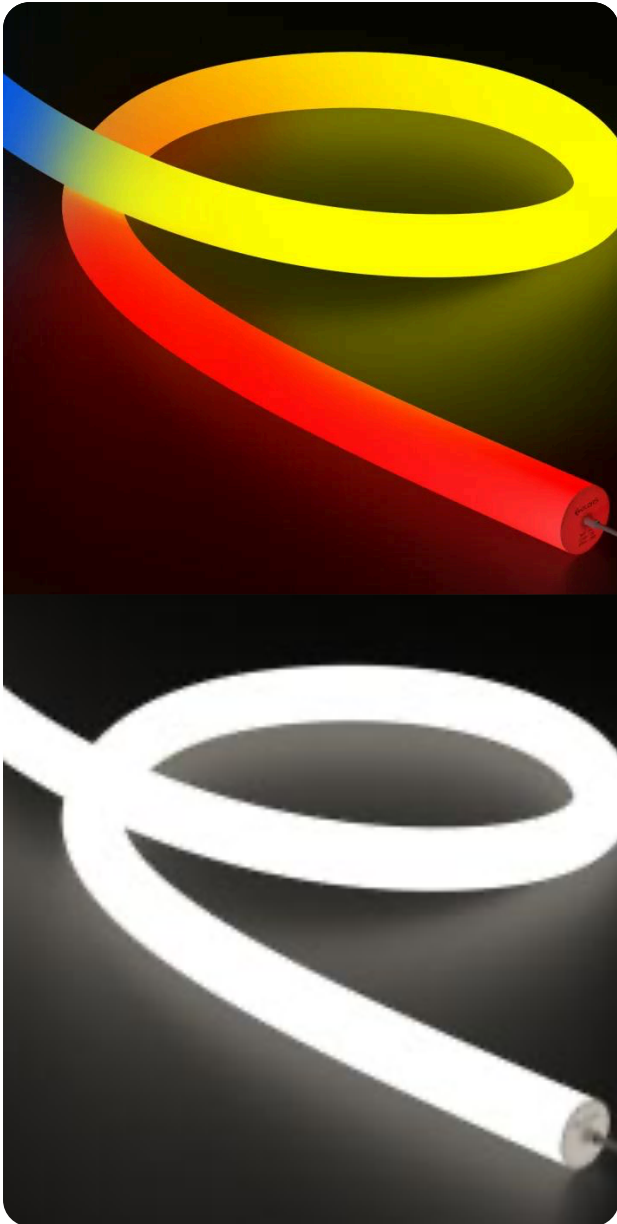

GENERAL INFORMATION:

The FLEX 360 Collection is a premium round-profile LED neon flex delivering true 360° omnidirectional illumination. Engineered with advanced silicone extrusion technology, it provides seamless, dot-free light output with consistent brightness from every viewing angle. The flexible construction allows smooth bending and shaping, making it ideal for creative architectural outlines, feature lighting, and decorative installations where uniform circular light distribution is required. Designed for both indoor and outdoor applications, the FLEX 360 series features durable, UV-resistant silicone housing with high ingress protection ratings for long-term reliability. Available in multiple diameters and configurations, including single color, tunable white, RGB, and RGBW options, the system supports various control protocols depending on the model. With high CRI performance, cut-to-length customization, and compatibility with standard LED drivers.

FIXTURE TYPE:

360 LED Neon Flexible

MATERIAL:

High Purity Silica Gel

IP RATING:

IP65

IP65

IK RATING:

IK08

IK08

WARRANTY:

LED lighting products are warranted for 5 years.

DRIVER POSITION:

Remote

MAIN FEATURES:

Full colour RGBW
Functional and minimalistic design
Skin-friendly surface treatment
Operating Temperature: -13°F to +131°F.

THINK BOLLARD - THINK BULLARD

sales@gordonbullard.com
www.bullardbollards.com
1-877-964-4646



991 South Gull Lake Dr
Richland, MI 49083
USA



FIXTURE TYPE: _____

PROJECT NAME: _____

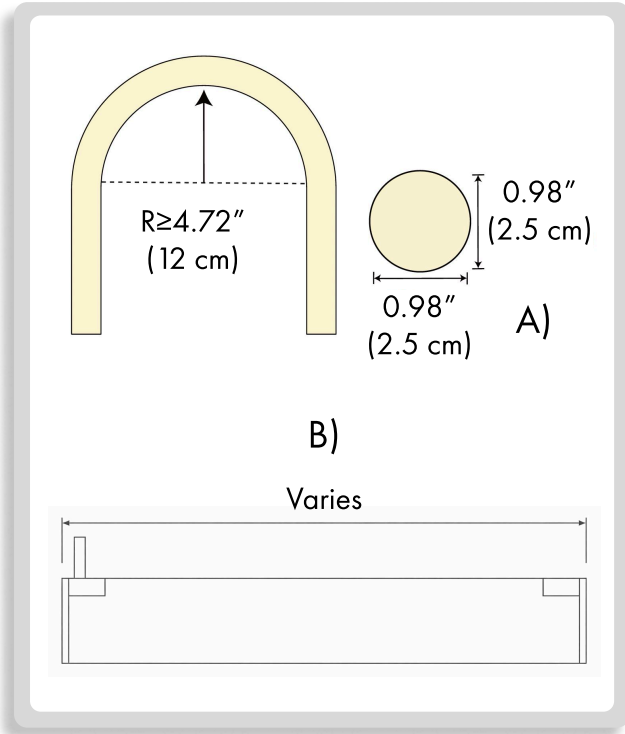

HOW TO ORDER:

CODE:

Example:
CODE: BB-FLX360R25-CL-LS1-ECT-AS-NNR25VTD-XX-2-402-02-000000-00001-402-02-000000-00013

BB-FLX360R25-CL-LS1-ECT-AS-NNR30VTD-XX-2-402-02-000000-00001-402-02-000000-00013

1 DIMENSIONS:

A) Diameter - Ø: 0.98" (2.5 cm)
B) Length - L: Varies

2 LIGHT SOURCE:

CODE	INPUT VOLTAGE	CCT	RATED POWER	CRI	LENGTH	LUMENS	CUTTING
-LS1 -LS2 -LS3 -LS4	24VDC	2300 K	14.4W (4.39W/ft)	90	16.4ft	750 (225/ft)	Arbitrary cutting 4LED/0.47"
		2700 K				950 (285/ft)	
		3000 K				950 (285/ft)	
		4000 K				950 (285/ft)	
-LS1G -LS2B	24VDC	Green	10W (3.05W/ft)	/	16.4ft	/	No cutting 14LED/1.64"
		Blue	14.4W (4.39W/ft)	/		510 (155/ft)	No cutting 14LED/1.97"
-LS1RGB		RGB	14.4W (4.39W/ft)	/		950 (285/ft)	No cutting 24LED/1.23"
-LS1CCT		2300K-4000K	14.4W (4.39W/ft)	90		950 (285/ft)	No cutting 24LED/1.23"
-LS1RGBW -LS2RGBW -LS3RGBW -LS4RGBW	24VDC	RGB-2300 K	17.2W (5.21 W/ft)	/	32.8ft	LW: 460 (140/ft)	No cutting 24LED/2.46"
		RGB-2800 K				SW: 500 (168/ft)	
		RGB-3200 K				WW: 570 (174/ft)	
		RGB-4500 K				NW: 570 (174/ft)	
-LSS1 -LSS2 -LSS3 -LSS4	48VDC	2300 K	12.5W (3.81 W/ft)	90	65.6ft	875 (265/ft)	No cutting 28LED/3.28"
		2700 K				1000 (303/ft)	
		3000 K				1000 (303/ft)	
		4000 K				1060 (321/ft)	
-LSS1RGBW -LSS2RGBW -LSS3RGBW -LSS4RGBW	48VDC	RGB-2300 K	17.2W (5.21 W/ft)	/	32.8ft	LW: 440 (134/ft)	No cutting 48LED/4.92"
		RGB-2800 K				SW: 510 (155/ft)	
		RGB-3200 K				WW: 540 (165/ft)	
		RGB-4500 K				NW: 540 (165/ft)	
-LSS1R -LSS2G -LSS1B -LSS2RGB	12VDC	Red	21.6W (6.5W/ft)	/	16.3ft	/	Arbitrary cutting 2LED/0.4" IC:(WS2815) 90Pixels/m
	Green	/					
	Blue	/					
	RGB	302 (92.1/ft)					

THINK BOLLARD - THINK BULLARD

sales@gordonbullard.com
www.bullardbollards.com
1-877-964-4646



991 South Gull Lake Dr
Richland, MI 49083
USA



FIXTURE TYPE: _____

PROJECT NAME: _____

HOW TO ORDER:

CODE:

Example:
CODE: BB-FLX360R25-CL-LS1-ECT-AS-NNR25VTD-
XX-2-402-02-000000-00001-402-02-000000-00013

BB-FLX360R25-CL-
LS1-ECT-AS-
NNR30VTD-
XX-2-402-02-00000
0-00001-402-02-00
0000-00013

3 ENTRY CABLE:

-ECT

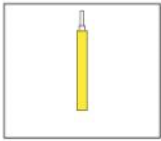

TOP

-ECS

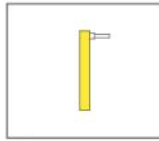

SIDE

4 ACCESSORIES:

-AS-NNR25VTD-XX-2

R25 Trimless embedded accessory



-AS-NNR25VRD-XX-2

R25 Embedded accessory



-AS-NNR25P1-25

R25 ceiling fixed installation components



-AS-NNR25GH0-EC

R25 Hole Diameter 4.5mm top cap



-AS-NNR25GS0-EC

R25 Hole Diameter 4.5mm side cap



-AS-NNR25GH1-EC

R25 Hole Diameter 5.6mm top cap



-AS-NNR25GS1-EC

R25 Hole Diameter 5.6mm side cap



-AS-NNR25LHS-0080

R25 No dark areas accessory



-AS-NNR25CCXS-B-3

Woven material
Ø110*H34mm with screws



-AS-NNR25CCXM-B-3

Woven material
Ø150*H34mm with screws



-AS-NNR25CCXL-B-3

Woven material
Ø175*H34mm with screws



-AS-NNR25C-053

Woven material
Ø110*H34mm with screws



THINK BOLLARD - THINK BULLARD

sales@gordonbullard.com

www.bullardbollards.com

1-877-964-4646



991 South Gull Lake Dr

Richland, MI 49083

USA



FIXTURE TYPE: _____

PROJECT NAME: _____

HOW TO ORDER:

CODE:

Example:
CODE: BB-FLX360R25-CL-LS1-ECT-AS-NNR25VTD-
XX-2-402-02-000000-00001-402-02-000000-00013

BB-FLX360R25-CL-
LS1-ECT-AS-
NNR30VTD-
XX-2-402-02-00000
0-00001-402-02-00
0000-00013

4 ACCESSORIES:

-AS-NNR25C-090

Woven material
Size: Ø41 * H90mm



-AS-FC-0001

2PIN
IP68 Quick
Waterproof
Connector

-AS-FC-0002

3PIN
IP68 Quick
Waterproof
Connector

-AS-FC-0003

4PIN
IP68 Quick
Waterproof
Connector



-AS-NNR25VHS1-1000

Vertical hanging side outlet
Install accessory kit (1 m)

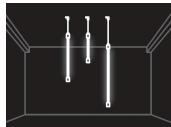

-AS-NNR25VHS1-2500

Vertical hanging side outlet
Install accessory kit (2.5m)

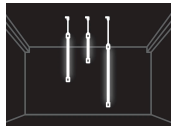

-AS-NNR25VHD1-1000

Hang the top vertically outlet
Install accessory kit (1 m)

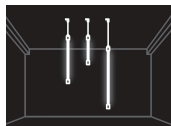

-AS-NNR25VHD1-2500

Vertical hanging from the top
Install accessory kit (2.5m)

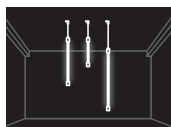

-AS-NNR25VCC1-1000

Single-ended vertical ceiling
Install accessory kit (1 m)

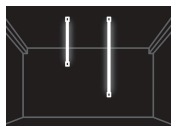

-AS-NNR25VCC1-2500

Single-ended vertical ceiling
Install accessory kit (2.5m)

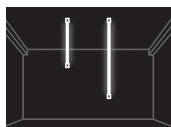

-AS-NNR25LCX-1000

Horizontal ceiling
Installation components

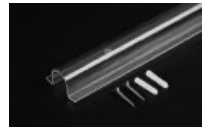
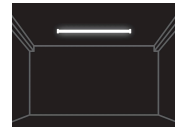

-AS-NNR25LHX-0038

Horizontal hoisting
Install components (38mm)

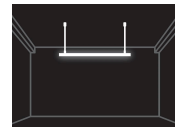

-AS-NNR25LHX-1000

Horizontal hoisting
Install components (1 m)

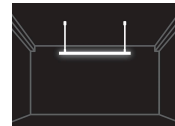

-AS-NNR25LHX-2500

Horizontal hoisting
Install components (2.5m)

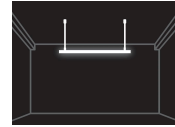

-AS-NNR25VCC1-XX-2

Double-ended vertical ceiling
Kits

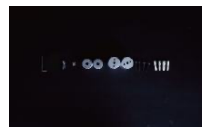
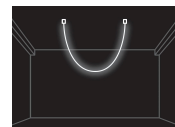

-AS-NNR25DHS-XX

Can be spliced
Install components

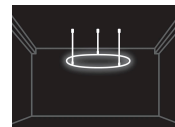

-AS-NNR25DCX-XX

Concealed
Install components

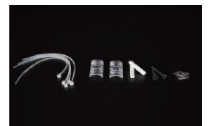
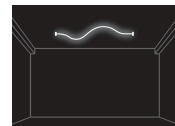

-AS-NNR25DHX-0038

Can be shaped and hoisted
Install components

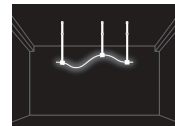

THINK BOLLARD - THINK BULLARD

sales@gordonbullard.com

www.bullardbollards.com

1-877-964-4646



991 South Gull Lake Dr

Richland, MI 49083

USA



FIXTURE TYPE: _____

PROJECT NAME: _____

HOW TO ORDER:

CODE:

Example:
CODE: BB-FLX360R25-CL-LS1-ECT-AS-NNR25VTD-
XX-2-402-02-000000-00001-402-02-000000-00013

BB-FLX360R25-CL-
LS1-ECT-AS-
NNR30VTD-
XX-2-402-02-00000
0-00001-402-02-00
0000-00013

5 SYSTEM CONTROL:

-402-02-000000-00001

Monochrome Remote Control
R6-1
Operating voltage: 3VDC(Battery CR2032)
Operating frequency: 2.4GHz
Remote control distance: 30m
Operating temperature: -30°C-55°C
Size:L107*W58.5*H9(mm)



-402-02-000000-00002

CCT Remote Control
R7-1
Operating voltage: 3VDC(Battery CR2032)
Operating frequency: 2.4GHz
Remote control distance: 30m
Operating temperature: -30°C-55°C



-402-0-000000-00013

Knob panel controller used for dimming to warm
CP1-GBB
Input voltage: 12-24VDC
Input current: 6A* 1CH
Operating temperature: -30°C-55°C
Size: L86*W86*H33(mm)



-402-01-000000-00002

CCT Control Receiver
CR2-GBA
Input voltage: 12-48VDC
Maximum load current: 8A*2CH, Max16A
Maximum load power: 192W/384W@12V/24V
1384W/576W@36V/48V
Operating temperature: -30°C-55°C
Size: L170*W50*H23(mm)



-402-02-000000-00013

Monochrome Control Receiver
CR1-GBA
Input voltage: 12-48VDC
Maximum load current: 15A* 1CH, Max15A@12/24V
10A * 1CH, Max10A@36/48V
Maximum load power: 15A* 1CH, Max15A@12/24V
10A * 1CH, Max10A@36/48V
Operating temperature: -30°C-55°C
Size: L175*W45*H27(mm)



-402-02-000000-00003

RGB/RGBW Remote Control
R8-1
Operating voltage: 3VDC (Battery CR2032)
Operating frequency: 2.4GHz
Remote control distance: 30m
Operating temperature: -30°C-55°C
Product Size: L107*W58.5*H9(mm)



THINK BOLLARD - THINK BULLARD

sales@gordonbullard.com
www.bullardbollards.com
1-877-964-4646



991 South Gull Lake Dr
Richland, MI 49083
USA

FIXTURE TYPE: _____

PROJECT NAME: _____

HOW TO ORDER:

CODE:

Example:
CODE: BB-FLX360R25-CL-LS1-ECT-AS-NNR25VTD-
XX-2-402-02-000000-00001-402-02-000000-00013

BB-FLX360R25-CL-
LS1-ECT-AS-
NNR30VTD-
XX-2-402-02-00000
0-00001-402-02-00
0000-00013

5 SYSTEM CONTROL:

-402-01-000000-00003

RGB Control Receiver
CR3-GBA
Input voltage: 12-48VDC
Maximum load current: 6A*3CH, Max 18A
Maximum load power: 216W/432W@12V/24V
648W/864@36V/48V
Operating temperature: -30°C-55°C
Size: L175*W45*H27(mm)



-23-01-00-0050

Programmable digital controller
K-8000C
Operating temperature: -20°C-85°C
Operating power supply: DC5V-24V input
Power consumption: 5W
Data transfer ports: 8 (8*1024 pixel)
Weight: 0.8 kg
Size: L180*W120*H30mm
Memory card: SD card
Storage capacity: 128MB-32GB
Card format: FAT/FAT32
Storage file: *.led



THINK BOLLARD - THINK BULLARD

sales@gordonbullard.com
www.bullardbollards.com
1-877-964-4646



991 South Gull Lake Dr
Richland, MI 49083
USA