



**BULLARD
BOLLARDS**
Think Bollard Think Bullard

INSTALLATION INSTRUCTION
01/28/2026

RAYZ



Exterior details

Luminaire

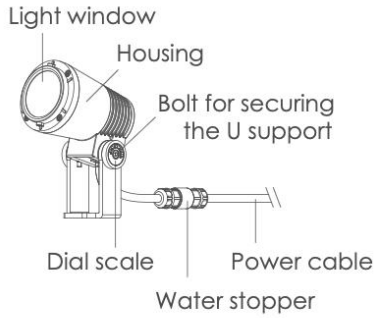

Optional accessories

Spike

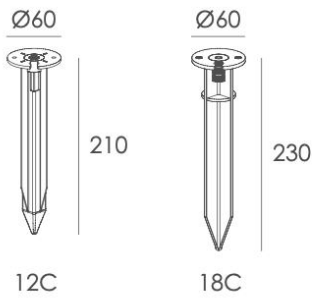

Spike

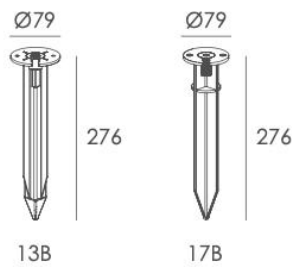

Bevel cut hood



Honeycomb Louver

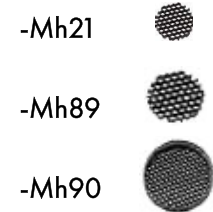

Round Surface Mounting Base



Data Sheet:

Input Voltage (V): 110-277
IK: 05

Installation steps

Step 1

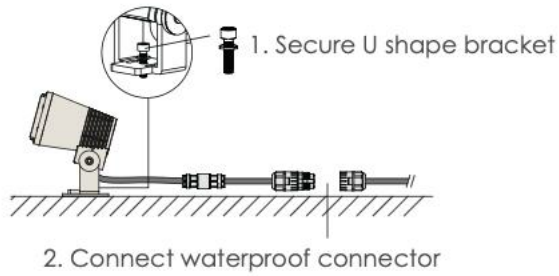

Step 2

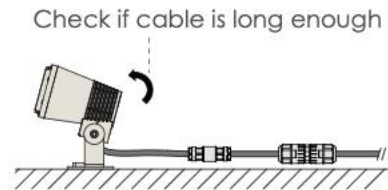

Accessories assemble - Spike

Step 1

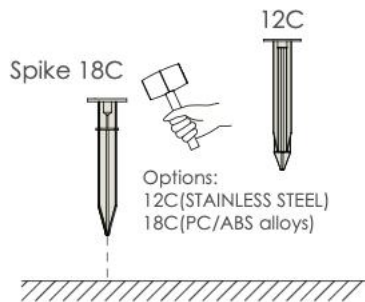

Step 2

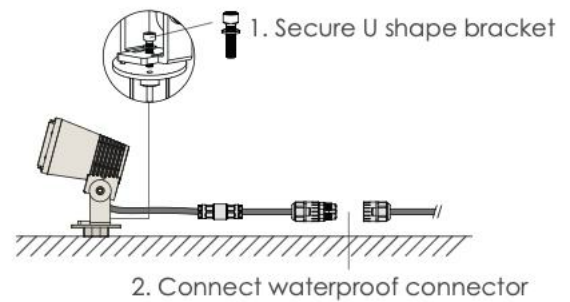

Step 3

