



**BULLARD
BOLLARDS**
Think Bollard Think Bullard

FLEX 360 R30
BB-FLX360R30-CL





FIXTURE TYPE: _____

PROJECT NAME: _____

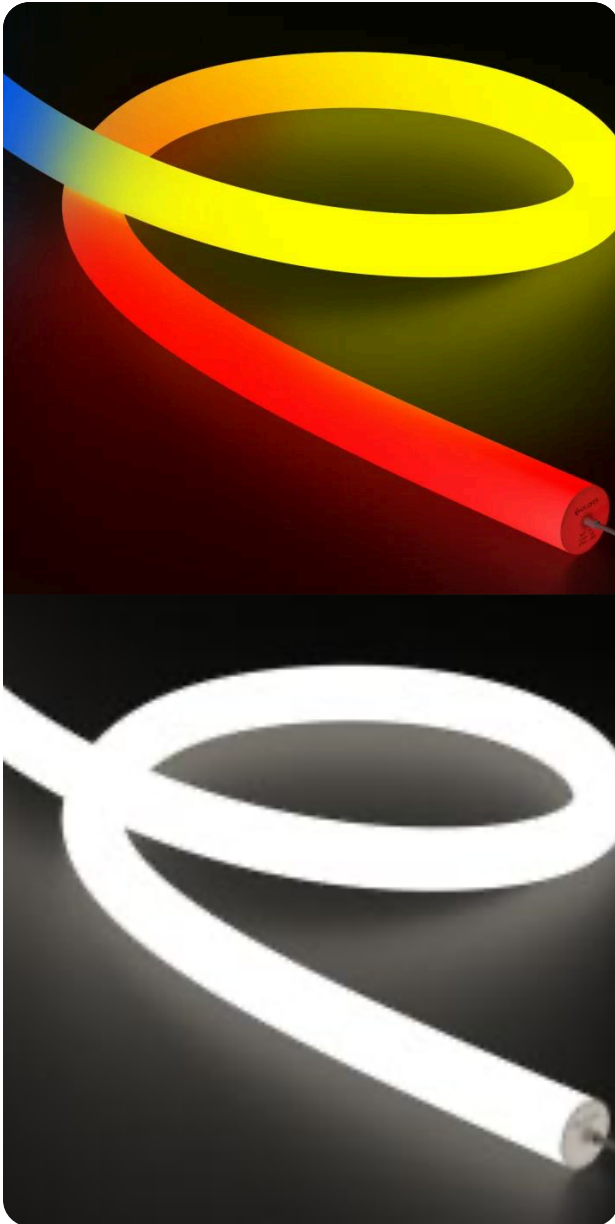

GENERAL INFORMATION:

The FLEX 360 Collection is a premium round-profile LED neon flex delivering true 360° omnidirectional illumination. Engineered with advanced silicone extrusion technology, it provides seamless, dot-free light output with consistent brightness from every viewing angle. The flexible construction allows smooth bending and shaping, making it ideal for creative architectural outlines, feature lighting, and decorative installations where uniform circular light distribution is required. Designed for both indoor and outdoor applications, the FLEX 360 series features durable, UV-resistant silicone housing with high ingress protection ratings for long-term reliability. Available in multiple diameters and configurations, including single color, tunable white, RGB, and RGBW options, the system supports various control protocols depending on the model. With high CRI performance, cut-to-length customization, and compatibility with standard LED drivers.

FIXTURE TYPE:

360 LED Neon Flexible

MATERIAL:

High Purity Silica Gel

IP RATING:

IP65

IP65

IK RATING:

IK08

IK08

WARRANTY:

LED lighting products are warranted for 5 years.

DRIVER POSITION:

Remote

MAIN FEATURES:

- Full colour RGBW
- Functional and minimalistic design
- Skin-friendly surface treatment
- Operating Temperature: -13°F to +131°F.

THINK BOLLARD - THINK BULLARD

sales@gordonbullard.com
www.bullardbollards.com
1-877-964-4646



991 South Gull Lake Dr
Richland, MI 49083
USA



FIXTURE TYPE: _____

PROJECT NAME: _____

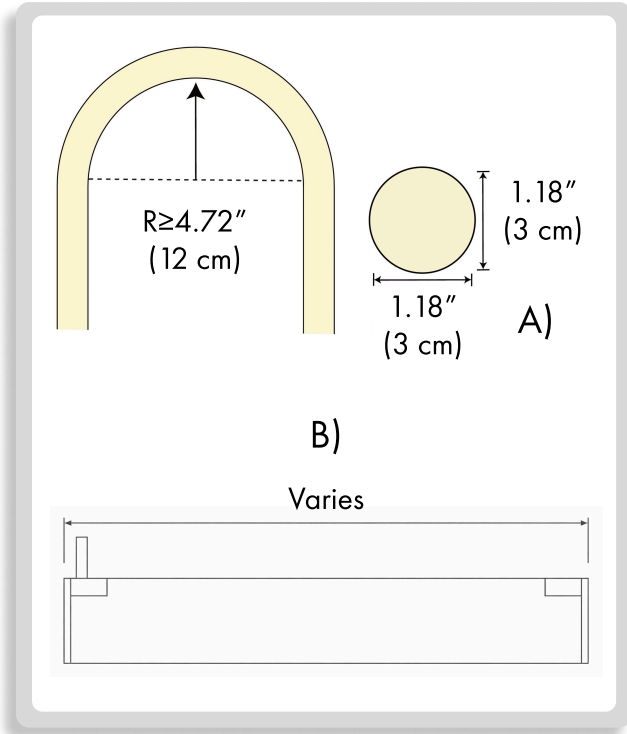

HOW TO ORDER:

CODE:

Example:
CODE: BB-FLX360R30-CL-LS1-ECT-AS-NNR30VTD-XX-2-402-02-000000-00001-402-02-000000-00013

BB-FLX360R30-CL-LS1-ECT-AS-NNR30VTD-XX-2-402-02-000000-00001-402-02-000000-00013

1 DIMENSIONS:

A) Diameter - Ø: 1.18" (3 cm)
B) Length - L: Varies

2 LIGHT SOURCE:

CODE	INPUT VOLTAGE	CCT	RATED POWER	CRI	LENGTH	LUMENS	CUTTING	
-LS1 -LS2 -LS3 -LS4	24VDC	2200 K	14.4W (4.39W/ft)	90	3.28ft or 8.2ft or 16.4ft	850 (259/ft)	Arbitrary cutting 4LED/0.47"	
		2700 K				950 (290/ft)		
		3000 K				950 (290/ft)		
		4000 K				950 (290/ft)		
-LS1G -LS2B	24VDC	Green	10W (3.05W/ft)	/	3.28ft or 8.2ft or 16.4ft	/	No cutting 14LED/1.64"	
		Blue				450 (137/ft)	No cutting 14LED/1.97"	
-LS1RGB		RGB				14.4W (4.39W/ft)	950 (290/ft)	No cutting 24LED/1.23"
-LS1CCT		2200K-4000K				14.4W (4.39W/ft)	90	950 (290/ft)
-LS1RGBW -LS2RGBW -LS3RGBW -LS4RGBW	24VDC	RGB-2300 K	17.2W (5.21W/ft)	/	32.8ft	LW: 450 (137/ft)	No cutting 24LED/2.46"	
		RGB-2800 K				SW: 500 (152/ft)		
		RGB-3200 K				WW: 540 (165/ft)		
		RGB-4500 K				NW: 540 (165/ft)		
-LSS1 -LSS2 -LSS3 -LSS4	48VDC	2200 K	12.5W (3.81W/ft)	90	65.6ft	850 (259/ft)	No cutting 28LED/3.28"	
		2700 K				950 (290/ft)		
		3000 K				950 (290/ft)		
		4000 K				950 (290/ft)		
-LSS1RGBW -LSS2RGBW -LSS3RGBW -LSS4RGBW	48VDC	RGB-2300 K	17.2W (5.21W/ft)	/	32.8ft	LW: 450 (137/ft)	No cutting 48LED/4.92"	
		RGB-2800 K				SW: 500 (152/ft)		
		RGB-3200 K				WW: 540 (165/ft)		
		RGB-4500 K				NW: 540 (165/ft)		
-LSS1R -LSS2G -LSS1B -LSS2RGB	12VDC	Red	21.6W (6.5W/ft)	/	16.3ft	/	Arbitrary cutting 2LED/0.4" IC:(WS2815) 90Pixels/m	
	Green	/						
	Blue	/						
	RGB	302 (92.1/ft)						

THINK BOLLARD - THINK BULLARD

sales@gordonbullard.com
www.bullardbollards.com
1-877-964-4646



991 South Gull Lake Dr
Richland, MI 49083
USA



FIXTURE TYPE: _____

PROJECT NAME: _____

HOW TO ORDER:

CODE:

Example:
CODE: BB-FLX360R30-CL-LS1-ECT-AS-NNR30VTD-
XX-2-402-02-000000-00001-402-02-000000-00013

BB-FLX360R30-CL-
LS1-ECT-AS-
NNR30VTD-
XX-2-402-02-00000
0-00001-402-02-00
0000-00013

3 ENTRY CABLE:

-ECT

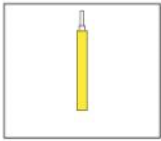

TOP

-ECS

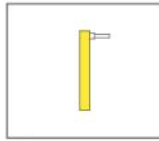

SIDE

4 ACCESSORIES:

-AS-NNR30VTD-XX-2

R30 Trimless embedded accessory



-AS-NNR30VRD-XX-2

R30 Embedded accessory



-AS-NNR30P1-25

R30 N-buckle accessory



-AS-NNR30LCX-1000

R30 N-groove accessory



-AS-NNR30DCX-XX

R30 Invisible buckle

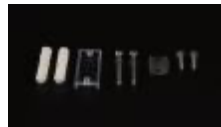

-AS-NNR30VCC-XX-2

R30 Ceiling mounting accessory

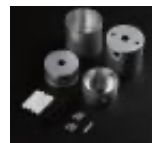

-AS-NNR30GH0-EC

R30 Hole Diameter 4.6mm top cap



-AS-NNR30GS0-EC

R30 Hole Diameter 4.6mm side cap



-AS-NNR30GH1-EC

R30 Hole Diameter 5.6mm top cap



-AS-NNR30GS1-EC

R30 Hole Diameter 5.6mm side cap



THINK BOLLARD - THINK BULLARD

sales@gordonbullard.com

www.bullardbollards.com

1-877-964-4646



991 South Gull Lake Dr

Richland, MI 49083

USA



FIXTURE TYPE: _____

PROJECT NAME: _____

HOW TO ORDER:

CODE:

Example:
CODE: BB-FLX360R30-CL-LS1-ECT-AS-NNR30VTD-
XX-2-402-02-000000-00001-402-02-000000-00013

BB-FLX360R30-CL-
LS1-ECT-AS-
NNR30VTD-
XX-2-402-02-00000
0-00001-402-02-00
0000-00013

5 SYSTEM CONTROL:

-402-02-000000-00001

Monochrome Remote Control
R6-1
Operating voltage: 3VDC(Battery CR2032)
Operating frequency: 2.4GHz
Remote control distance: 30m
Operating temperature: -30°C-55°C
Size:L107*W58.5*H9(mm)



-402-02-000000-00002

CCT Remote Control
R7-1
Operating voltage: 3VDC(Battery CR2032)
Operating frequency: 2.4GHz
Remote control distance: 30m
Operating temperature: -30°C-55°C



-402-0-000000-00013

Knob panel controller used for dimming to warm
CP1-GBB
Input voltage: 12-24VDC
Input current: 6A*1CH
Operating temperature: -30°C-55°C
Size: L86*W86*H33(mm)



-402-01-000000-00002

CCT Control Receiver
CR2-GBA
Input voltage: 12-48VDC
Maximum load current: 8A*2CH, Max16A
Maximum load power: 192W/384W@12V/24V
1384W/576W@36V/48V
Operating temperature: -30°C-55°C
Size: L170*W50*H23(mm)



-402-02-000000-00013

Monochrome Control Receiver
CR1-GBA
Input voltage: 12-48VDC
Maximum load current: 15A*1CH, Max15A@12/24V
10A*1CH, Max10A@36/48V
Maximum load power: 15A*1CH, Max15A@12/24V
10A*1CH, Max10A@36/48V
Operating temperature: -30°C-55°C
Size: L175*W45*H27(mm)



-402-02-000000-00003

RGB/RGBW Remote Control
R8-1
Operating voltage: 3VDC (Battery CR2032)
Operating frequency: 2.4GHz
Remote control distance: 30m
Operating temperature: -30°C-55°C
Product Size: L107*W58.5*H9(mm)



THINK BOLLARD - THINK BULLARD

sales@gordonbullard.com
www.bullardbollards.com
1-877-964-4646



991 South Gull Lake Dr
Richland, MI 49083
USA



FIXTURE TYPE: _____

PROJECT NAME: _____

HOW TO ORDER:

CODE:

Example:
CODE: BB-FLX360R30-CL-LS1-ECT-AS-NNR30VTD-
XX-2-402-02-000000-00001-402-02-000000-00013

BB-FLX360R30-CL-
LS1-ECT-AS-
NNR30VTD-
XX-2-402-02-00000
0-00001-402-02-00
0000-00013

5

SYSTEM CONTROL:

-402-01-000000-00003

RGB Control Receiver
CR3-GBA
Input voltage: 12-48VDC
Maximum load current: 6A*3CH, Max 18A
Maximum load power: 216W/432W@12V/24V
648W/864@36V/48V
Operating temperature: -30°C-55°C
Size: L175*W45*H27(mm)



-23-01-00-0050

Programmable digital controller
K-8000C
Operating temperature: -20°C-85°C
Operating power supply: DC5V-24V input
Power consumption: 5W
Data transfer ports: 8 (8*1024 pixel)
Weight: 0.8 kg
Size: L180*W120*H30mm
Memory card: SD card
Storage capacity: 128MB-32GB
Card format: FAT/FAT32
Storage file: *.led

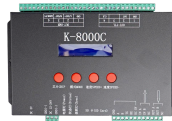

THINK BOLLARD - THINK BULLARD

sales@gordonbullard.com
www.bullardbollards.com
1-877-964-4646



991 South Gull Lake Dr
Richland, MI 49083
USA