

**BULLARD
SOLAR**
One with the Sun

SSLX PERFORMANCE 40 SOLAR STREET LIGHT SPLIT





FIXTURE TYPE: _____

PROJECT NAME: _____



GENERAL INFORMATION:

Based in same design as the SSLXPRO, the SSLX PERFORMANCE maintains all of the same quality technology and components while offering a simpler design with the purpose of offering a more affordable solution without compromise on durability and performance

NOMINAL FLUX 7 840 LUMENS
NOMINAL POWER 40 WATTS

LIGHTING

Efficiency 196 Lumens/Watts
Chips LED PHILIPS Luxeon 30-30
LED lifetime Over 80 000 hours LM80
Optics/CCT TII-S / T3-M/ T-V -- 2300 to 6500K
Light Height From 5 to 6 Meters (From 196.85" to 236.22")

BATTERY

Technology Lithium Iron Phosphate LIFEPO4
Capacity 627.2 Wh
Autonomy Over 24 hours at full charge - 4 Rainy Days back up
Charging time 5-6 hours
Lifespan Over 3000 CYCLES @ 80% DOD over 10 years Lifetime
Working temp 14°F to 158°F (optional -40°F to 158°F) -10°C to 70°C (optional -40°C TO 70°C)

ENERGY

Solar panel 135 Watts /18V
Cells type Monocrystalline Panel Grade A 25 years
Certificates IEC 61215 - IEC 61730 I and II - IEC 60904

ELECTRONIC

Controller MPPT SMART CONTROLLER (Bullard Solar BRIDGE optional)
Sensor Microwave 360° Motion Sensor
Cabling Waterproof Connector, Plug and Play
Protection Battery Management System (BMS)

MECHANICAL

Pole mounting 89mm - 76mm (3.50" x 3.00")
Material Aluminium and Stainless Steel

DIMENSIONS

Product 38.98" x 26.38" x 10.67" (99 cm x 67 cm x 27.1cm)
Carton size 41.73" x 28.74 x 9.65" (106 cm x 73 cm x 24.5 cm)
Net Weight 14.5 KG (31,97 lb)
Gross Weight 20 KG (44,09 lb)
QTY /CTN 20"/40' 118/24



Hiking Trails



Car Parks & Rest Areas



Main Roads



Secondary Roads

CERTIFICATIONS

IEC / TUV / EMC / LM-79- 08
AND LM-80 TEST STANDARDS
/ IK8 / IP65 / CE / ULOR

**5
YEARS**

*Bullard Solar offers a 5 Year Limited Warranty for the SSLX Performance luminaire shall be free from defects in material and workmanship for up to five (5) years from date of shipment. This limited warranty covers all components when installed and operated according to Bullard Solar instructions. Fixture suitable for ambient temperature from -10° to 50°. PV Panels - 20 year performance warranty Controller & Batteries: 5 years

Bullard Solar retains the right to modify or change product specifications without prior notice, as part of our ongoing commitment to improvement

ONE WITH THE SUN

sales@gordonbullard.com
www.bullardsolar.com
1-877-964-4646



991 South Gull Lake Dr
Richland, MI 49083
USA

FIXTURE TYPE: _____

PROJECT NAME: _____

LUMINAIRE HOUSING & LEDS

7 840 LUMENS - 2300 TO 6500 K

Extruded low-copper aluminum. Protection class (IP65). Bullard Solar uses a high quality Polyester Powder Coating from AKZO NOBEL. This powder coating provides an excellent salt and humidity resistance as well as ultra violet resistance for color retention for this product. Our Luminaire is equipped with PHILIPS LUXEON HE PLUS High efficiency Chips offering an overall 196 Lumens per Watt efficacy. Our luminaire also complies with the DARK SKY requirement for light pollution with an Upward lighting of 0.31%.



LED	3030	LED QTY (PCS)	72	LENS (PCS)	35	CRI	> 80
-----	-------------	---------------	-----------	------------	-----------	-----	----------------



DIFFERENT OPTICS *

Our different optics will allow you to optimize the lighting results of your projects



* Please contact us for more optics.

LIGHT DISTRIBUTION CURVES

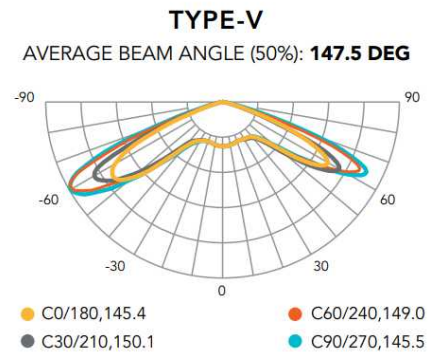
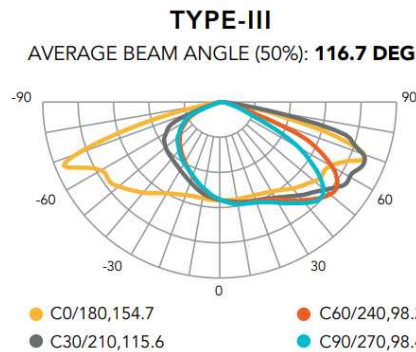
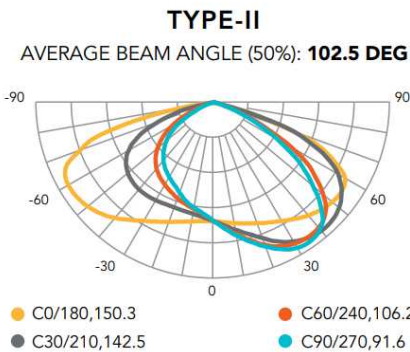

ONE WITH THE SUN

sales@gordonbullard.com
www.bullardsolar.com
1-877-964-4646



991 South Gull Lake Dr
Richland, MI 49083
USA

FIXTURE TYPE: _____

PROJECT NAME: _____

+ OVER 10 YEARS LIFESPAN

The SSLX Performance Series is equipped with Iron Phosphate Lithium LiFePo4 battery. This technology is proved to be the best chemical technology for solar application on the market. With a cycle life of over 3000 Cycles @ 80% DOD, the battery enjoys lifespan of over 10 years.

EXTREME TEMPERATURE

14°F to 158°F / -10 °C to 70°C

When Standard Lithium LiFePo4 batteries enjoy a working temperature range from 14°F to 158°F (-10°C TO 70°C). Bullard Solar offers as optional a new Special LIFEPO4 battery with working range of -40°F to 158°F (-40 °C. to 70 °C).

EASY MAINTENANCE & ANTI THEFT SCREWS

Easy and direct access to the battery casing for maintenance. The fixation are made with anti theft screws, which request special tooling to unscrew.

**BMS ELECTRONIC PROTECTION
BATTERY MANAGEMENT SYSTEM**

Our batteries are equipped with electronic circuit boards for a higher protection, ensuring battery functioning optimization no matter the situation.

THE BMS PROTECTS AGAINST

- OVER/UNDER CURRENT • OVERLOAD • OVER/UNDER VOLTAGE
- OVER/UNDER CHARGE • TEMPERATURE MANAGEMENT

BATTERY LIFEPO4

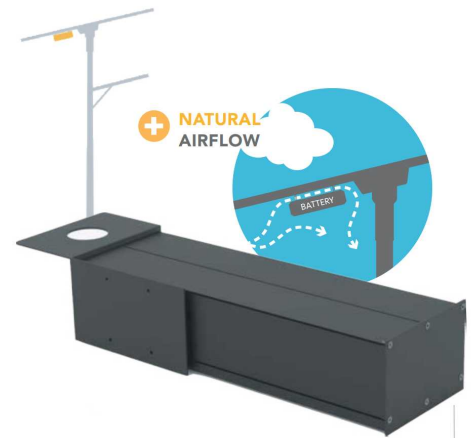

ALUMINUM WATERPROOF CASING & NATURAL AIRFLOW

High temperatures greatly negatively affect the battery's lifespan. This is why our batteries are encapsulated in an aluminum waterproof casing for a perfect heat dissipation. In addition to that, the casing enjoys a natural airflow which keeps the battery to ambient temperature.

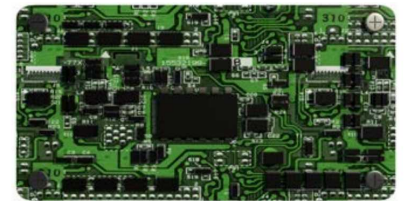

COMPARISONS OF DIFFERENT BATTERY TECHNOLOGIES

LIFETIME & CYCLES AT 80% DOD*
Comparison of different battery technologies

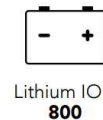
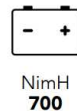

CHARGING TEMPERATURE RANGE WITHOUT CAPACITY LOSS
Minimum & Maximum temperature range for Optimal charging during the day

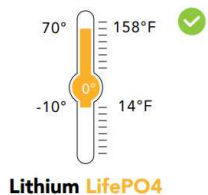
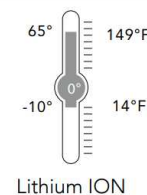
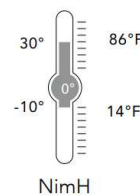
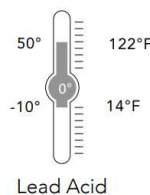

ONE WITH THE SUN

sales@gordonbullard.com
www.bullardsolar.com
1-877-964-4646



991 South Gull Lake Dr
Richland, MI 49083
USA

FIXTURE TYPE: _____

PROJECT NAME: _____

SOLAR PANEL

135 WATTS

High efficiency mono-crystalline Solar panels. Carefully selected Grade A Solar cells. Up to 20.4% efficiency, all protected by self-cleaning tempered glass at 30 degrees of inclination. Its anodized aluminium alloy frame gives it a modern and elegant design as well as perfect resistance to corrosion. They are also equipped with fully waterproof Plug and Play connectors.

solar cells
GRADE A

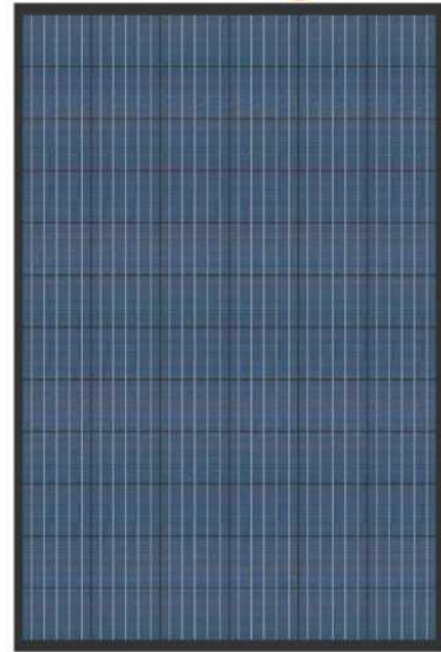

OUR PV PERFORMANCE GUARANTEE

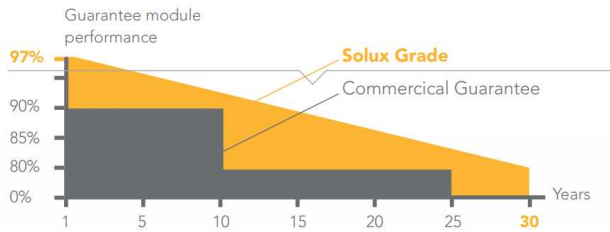

CONTROLLER MPPT



**+ WATERPROOF CONNECTORS
"PLUG & PLAY"**

All our components are assembled **seamless and easy to access**

In a search for performance and reliability, our products are equipped with MPPT technology controller offering the best charging efficiency on the market up to 98%

REMOTE CONTROL MONITORING

In order to facilitate all maintenance operations and above all to diagnose any possible problem, without having to intervene mechanically on the luminaire, BULLARD SOLAR luminaires are equipped with a wireless diagnostic system via remote control



With a simple click it is possible to have real-time information such as:

- Automatic diagnosis in case of malfunction
- State of charge and battery history
- Real Time load and solar panel energy production history
- Age of the product and installation Temperature and its history

FEATURES

- Minimal stand-by power consumption
- Current consumption $\leq 10\text{mA}$
- Intelligent battery management

3 Phases charging:

- Charge MPPTT
- Constant voltage
- Floating voltage

- Intelligent LED driver Auto detecting of Dusk and Dawn for automatic operation, 7 Lighting Programs Configuration.
- ANTI BLACK OUT: Load adjust according to battery capacity assuring all night long lighting in any weather conditions.
- The controller also acts against:

- OVERLOAD
- OVERCURREN
- OVERTEMPERATURE
- OVERVOLTAGE / OVERLOAD
- OVERDISCHARGE

ONE WITH THE SUN

sales@gordonbullard.com
www.bullardsolar.com
1-877-964-4646



991 South Gull Lake Dr
Richland, MI 49083
USA

FIXTURE TYPE: _____

PROJECT NAME: _____

MOTION SENSOR MICROWAVE

Bullard Solar luminaires are equipped with microwave sensors that use the Doppler effect (like car radars) to detect a near-by objects and measure the distance. The sensor emits a high frequency wave to reflect off of and analyze the objects in the vicinity. Since the microwaves only detect specific objects, detection reliability increases resulting in:

- Much better reliability compared to the Infrared sensor
- Up to 360° Directivity
- Insensitivity to other environmental variations such as light, color, temperature, etc.

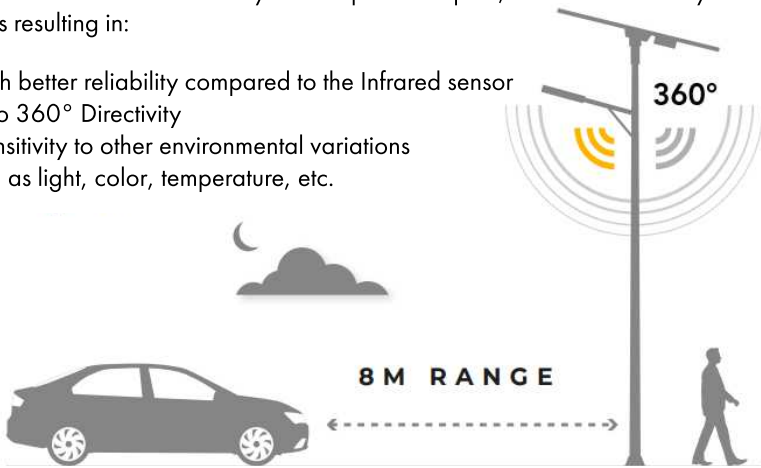

OPERATION MODE & LIGHTING SCHEDULE

In addition to automatic switching on and off, you have the possibility of choosing among different modular operating modes according to the needs of the project

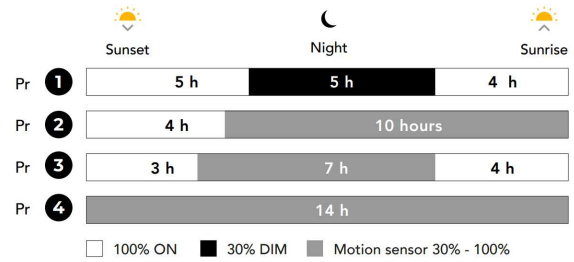

CONTACT US FOR MORE PROGRAM OPTIONS

BULLARD SOLAR BRIDGE REMOTE MONITORING

As part of his continuous effort for development, the Bullard Solar team is proud to have developed a special tool for remote monitoring of our solar street light. Bullard Solar Bridge uses low frequency technology LORA or ZIGBEE to monitor in real time a batch of solar street lights. YOU CAN NOW MANAGE YOUR SOLAR PARK REMOTELY:

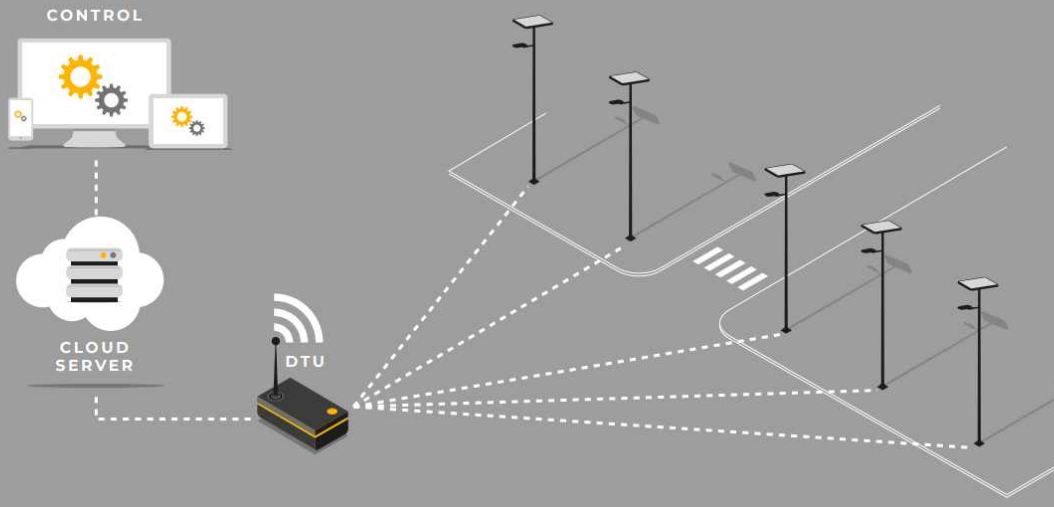

- INTERNET 2G/3G/4G 
- CONNECTION SECURE 
- GREAT RANGE OF COMMUNICATION 
- LOW CONSUMPTION 

ONE WITH THE SUN

sales@gordonbullard.com
www.bullardsolar.com
1-877-964-4646



991 South Gull Lake Dr
Richland, MI 49083
USA



**BULLARD
SOLAR**
One with the Sun

CODE:
SX

FIXTURE TYPE: _____

PROJECT NAME: _____

EASY INSTALLATION

NO CABLING | NO TRENCHING

With a well designed bracket support, SSLX Performance is effortless and flexible to install. Free 360° rotation of the panel to always face the Sun

INSERT, ORIENTATE & CHOOSE YOUR TILT



DIMENSIONS *

SOLAR PANEL & LED

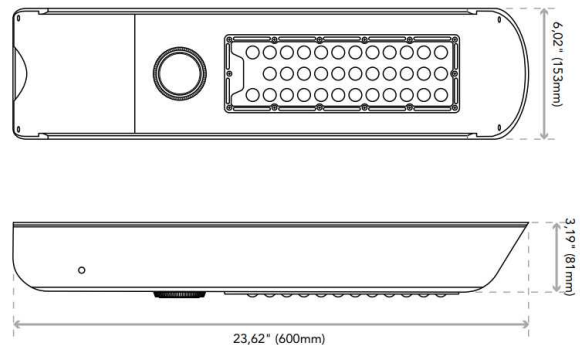
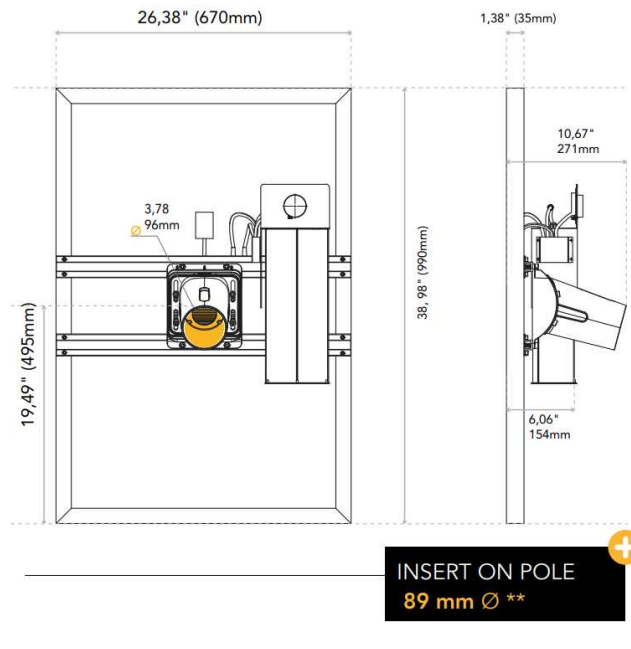
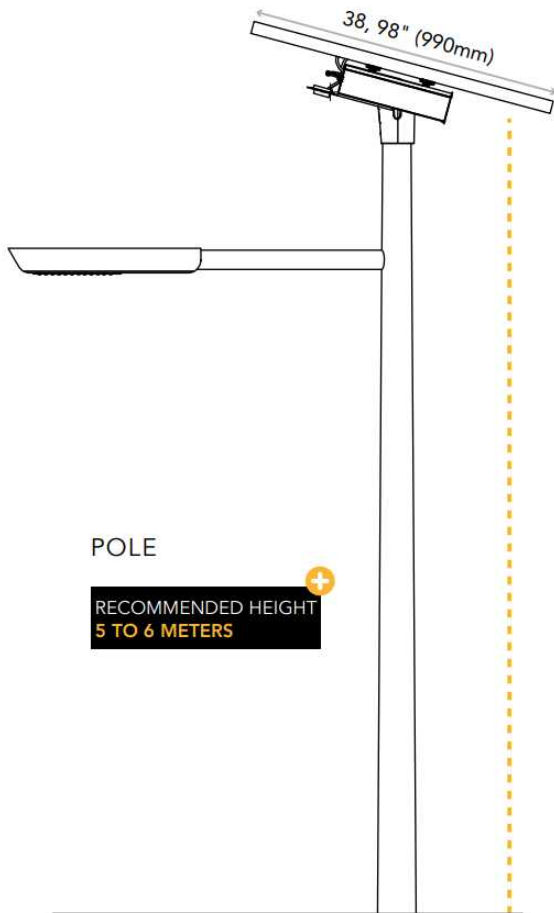

* All dimensions are in mm

** Available in 76mm Ø

ONE WITH THE SUN

sales@gordonbullard.com
www.bullardsolar.com
1-877-964-4646



991 South Gull Lake Dr
Richland, MI 49083
USA

Due to the dynamic nature of lighting products and the associated technologies, luminaire data on all specification sheets is subject to change at the discretion of Gordon Bullard LLC and associated companies.

© Bullard & Company 2024 All Rights Reserved

Updated 07/09/2024

FIXTURE TYPE: _____

PROJECT NAME: _____

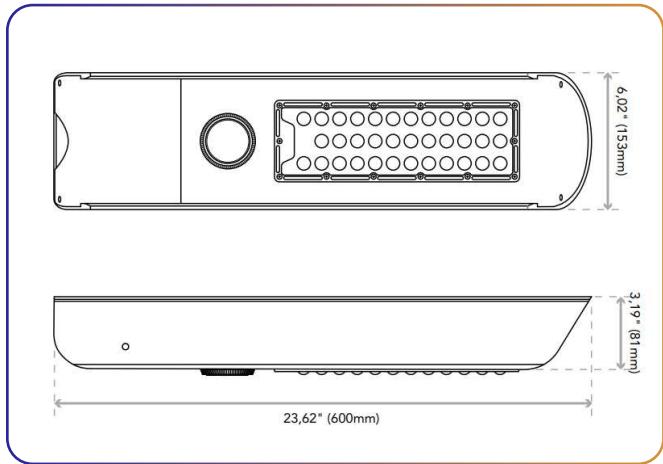
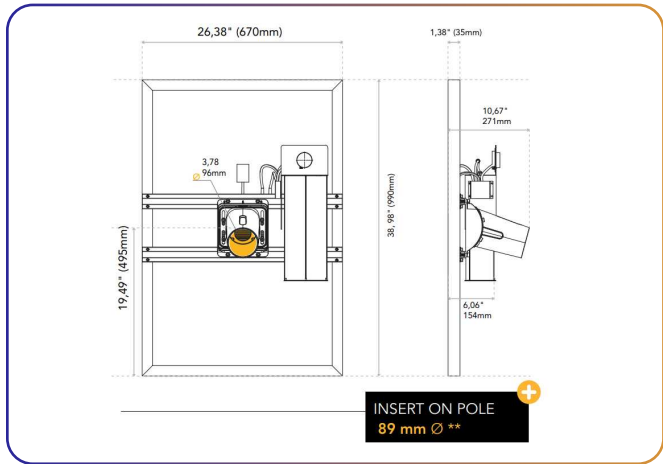
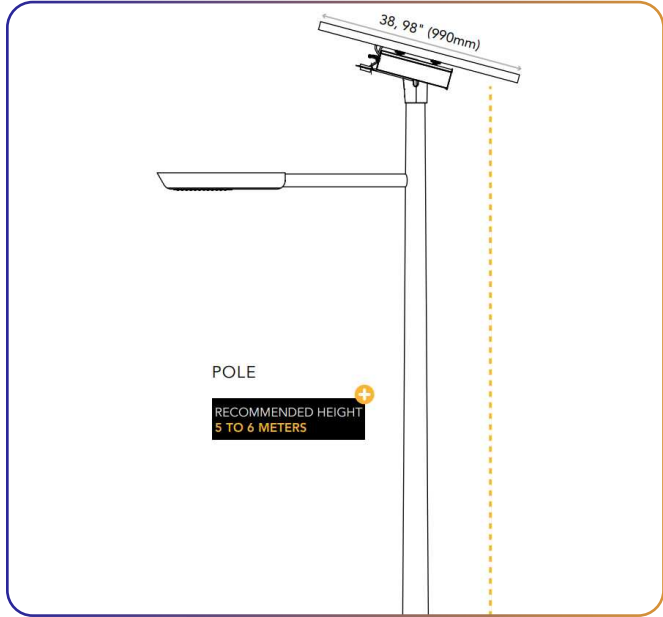

HOW TO ORDER:

CODE:

Example:
CODE: SX-40-BL-23K

SX-40-BL-23K

1 DIMENSIONS:

-40

-40
38.98" x 26.38" x 10.67" (99 cm x 67 cm x 27.1 cm)

2 FINISH OPTIONS:

-BL

-BL Black

3 CCT:

-23K 2300K
-30K 3000K
-40K 4000K
-50K 5000K
-65K 6500K

ONE WITH THE SUN

sales@gordonbullard.com
www.bullardsolar.com
1-877-964-4646



991 South Gull Lake Dr
Richland, MI 49083
USA