

**BULLARD  
SOLAR**  
One with the Sun

# SSLX PRO DUAL 50 SOLAR STREET LIGHT SPLIT





FIXTURE TYPE: \_\_\_\_\_

PROJECT NAME: \_\_\_\_\_

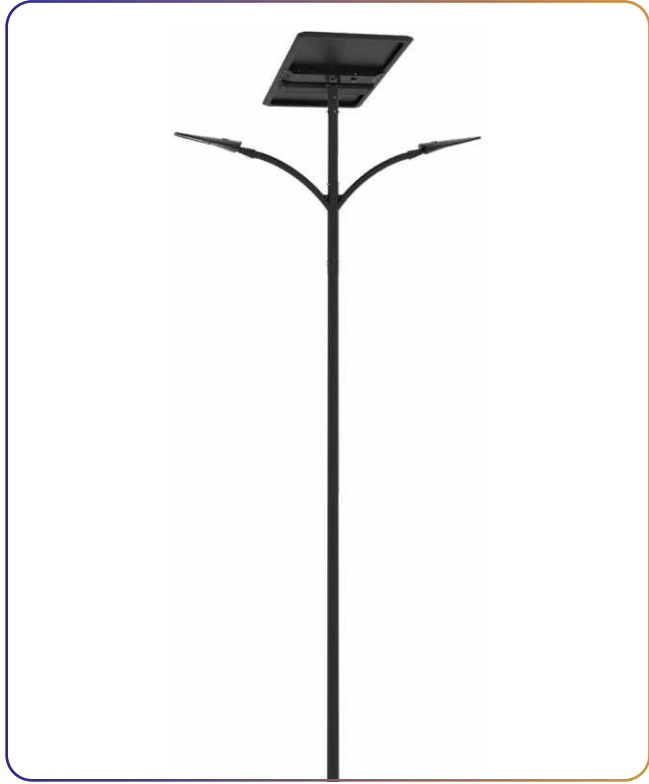

**GENERAL INFORMATION:**

SSLX PRO series enjoy a smart and unique design together with the best components available on the market. Using LiFePo4 Battery, MPPT controller and also made in aluminum makes it the most powerful and reliable solar street light solution.

NOMINAL FLUX ..... 2 x 9800 LUMENS  
NOMINAL POWER ..... 2 x 50 WATTS

**LIGHTING**

Efficiency ..... 196 Lumens/Watts  
Chips LED ..... PHILIPS Luxeon 30-30  
LED lifetime ..... Over 80 000 hours LM80  
Optics/CCT ..... TII-S / T3-M/ T-V -- 2300 to 6500K  
Light Height ..... From 6 to 10 meters (From 236.22" to 393.70")

**BATTERY**

Technology ..... Lithium Iron Phosphate LIFEPO4  
Capacity ..... 1498 Wh  
Autonomy ..... Over 24 hours at full charge - 4 Rainy Days back up  
Charging time ..... 5-6 hours  
Lifespan ..... Over 3000 CYCLES @ 80% DOD over 10 years Lifetime  
Working temp ..... 14°F to 158°F (optional -40°F to 158°F) -10°C to 70°C (optional -40°C TO 70°C)

**ENERGY**

Solar panel ..... 285 Watts /18V  
Cells type ..... Monocrystalline Panel Grade A 25 years  
Certificates ..... IEC 61215 - IEC 61730 I and II - IEC 60904

**ELECTRONIC**

Controller ..... MPPT SMART CONTROLLER (Bullard Solar BRIDGE optional)  
Sensor ..... Microwave 360° Sensor  
Cabling ..... Waterproof Connector, Plug and Play  
Protection ..... Battery Management System (BMS)

**MECHANICAL**

Pole mounting ..... 89mm - 76mm (3.50" x 3.00")  
Material ..... Aluminium and Stainless Steel

**DIMENSIONS**

Product ..... (69.69" x 41.73" x 5.91") 177 cm x 106 cm x 15 cm  
Carton size ..... (71.85" x 43.70" x 10.04") 182.5 cm x 111 cm x 25.5 cm  
Net Weight ..... 40.5 KG (89,29 lb)  
Gross Weight ..... 46.5 KG (102,52 lb)  
QTY / CTN 20"/40' ..... 47/98



Hiking Trails



Main Roads



Car Parks & Rest Areas



Secondary Roads

CERTIFICATIONS IEC / TUV / EMC / LM-79- 08 AND LM-80 TEST STANDARDS / IK8 / IP65 / CE / ULOR

**5 YEARS**

\* Bullard Solar offers a 5 Year Limited Warranty for the SSLXPRO-Series luminaire shall be free from defects in material and workmanship for up to five (5) years from date of shipment. This limited warranty covers all components when installed and operated according to Bullard Solar instructions. Fixture suitable for ambient temperature from -10° to 50°. PV Panels - 20 year performance warranty Controller & Batteries: 5 years

Bullard Solar retains the right to modify or change product specifications without prior notice, as part of our ongoing commitment to improvement

**ONE WITH THE SUN**

sales@gordonbullard.com  
www.bullardsolar.com  
1-877-964-4646



991 South Gull Lake Dr  
Richland, MI 49083  
USA

FIXTURE TYPE: \_\_\_\_\_

PROJECT NAME: \_\_\_\_\_

# LUMINAIRE HOUSING & LEDS

**2 x 9800 LUMENS - 2300 TO 6500 K**

High pressure die-cast low-copper aluminum. Protection class (IP65). Bullard Solar uses a high quality Polyester Powder Coating from AKZO NOBEL. This powder coating provides an excellent salt and humidity resistance as well as ultra violet resistance for color retention for this product. Our Luminaire is equipped with PHILIPS LUXEON HE PLUS High efficiency Chips offering an overall 196 Lumens per Watt efficiency. Our luminaire also complies with the DARK SKY requirement for light pollution with an Upward lighting of 0.31%.



LED	<b>3030</b>	LED QTY (PCS)	<b>96</b>	LENS (PCS)	<b>4</b>	CRI	<b>&gt; 80</b>
-----	-------------	---------------	-----------	------------	----------	-----	----------------

## DIFFERENT OPTICS \*

Our different optics will allow you to optimize the lighting results of your projects



\* Please contact us for more optics.

## LIGHT DISTRIBUTION CURVES

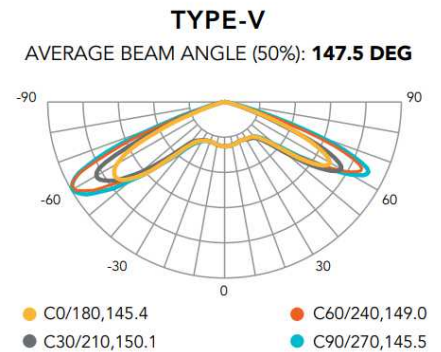
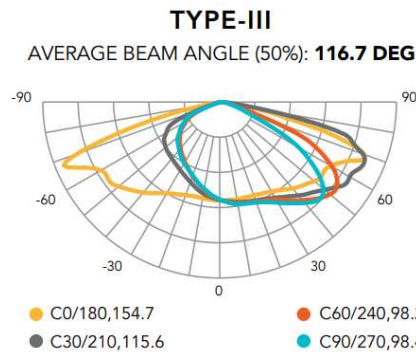
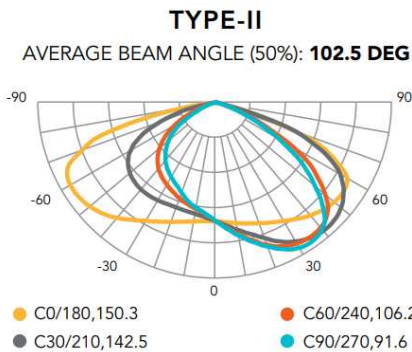

### ONE WITH THE SUN

sales@gordonbullard.com  
www.bullardsolar.com  
1-877-964-4646



991 South Gull Lake Dr  
Richland, MI 49083  
USA

FIXTURE TYPE: \_\_\_\_\_

PROJECT NAME: \_\_\_\_\_

**+ OVER 10 YEARS LIFESPAN**

The SSLXPRO Series is equipped with Iron Phosphate Lithium LiFePo4 battery. This technology is proved to be the best chemical technology for solar application on the market. With a cycle life of over 3000 Cycles @ 80% DOD, the battery enjoys lifespan of over 10 years.

**EXTREME TEMPERATURE**

14°F to 158°F / -10 °C to 70°C

When Standard Lithium LiFePo4 batteries enjoy a working temperature range from 14°F to 158°F (-10°C TO 70°C). Bullard Solar offers as optional a new Special LIFEPO4 battery with working range of -40°F to 158°F (-40 °C. to 70 °C).

**EASY MAINTENANCE & ANTI THEFT SCREWS**

Easy and direct access to the battery casing for maintenance. The fixation are made with anti theft screws, which request special tooling to unscrew.

**BMS ELECTRONIC PROTECTION  
BATTERY MANAGEMENT SYSTEM**

Our batteries are equipped with electronic circuit boards for a higher protection, ensuring battery functioning optimization no matter the situation.

**THE BMS PROTECTS AGAINST**

- OVER/UNDER CURRENT • OVERLOAD • OVER/UNDER VOLTAGE
- OVER/UNDER CHARGE • TEMPERATURE MANAGEMENT

**BATTERY LIFEPO4**

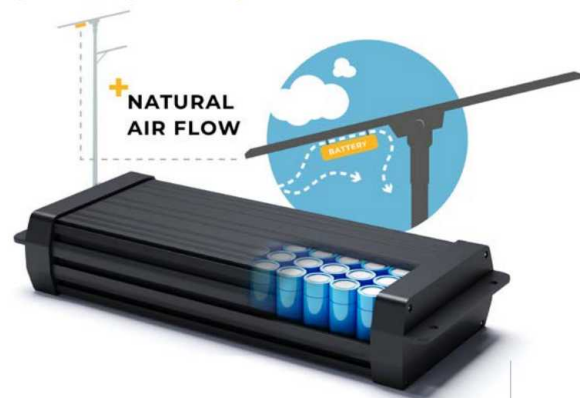

**ALUMINUM WATERPROOF CASING & NATURAL AIRFLOW**

High temperatures greatly negatively affect the battery's lifespan. This is why our batteries are encapsulated in an aluminum waterproof casing for a perfect heat dissipation. In addition to that, the casing enjoys a natural airflow which keeps the battery to ambient temperature.

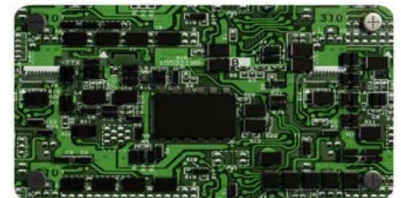

**COMPARISONS OF DIFFERENT BATTERY TECHNOLOGIES**

**LIFETIME & CYCLES AT 80% DOD\***  
*Comparison of different battery technologies*

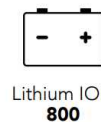
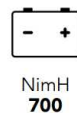

**CHARGING TEMPERATURE RANGE WITHOUT CAPACITY LOSS**  
*Minimum & Maximum temperature range for Optimal charging during the day*

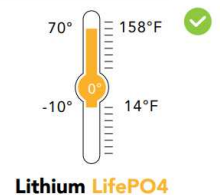
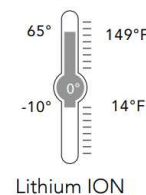
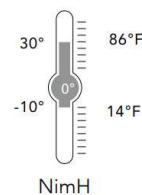
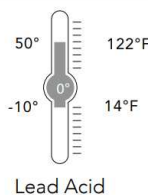

**ONE WITH THE SUN**

sales@gordonbullard.com  
www.bullardsolar.com  
1-877-964-4646



991 South Gull Lake Dr  
Richland, MI 49083  
USA

FIXTURE TYPE: \_\_\_\_\_

PROJECT NAME: \_\_\_\_\_

# SOLAR PANEL

## 285 WATTS

High efficiency mono-crystalline Solar panels. Carefully selected Grade A Solar cells. Up to 20.4% efficiency, all protected by self-cleaning tempered glass at 30 degrees of inclination. Its octagonal Anodized aluminium alloy frame gives it a modern and elegant design as well as perfect resistance to corrosion. They are also equipped with fully waterproof Plug and Play connectors.

solar cells  
**GRADE A**



### OUR PV PERFORMANCE GUARANTEE

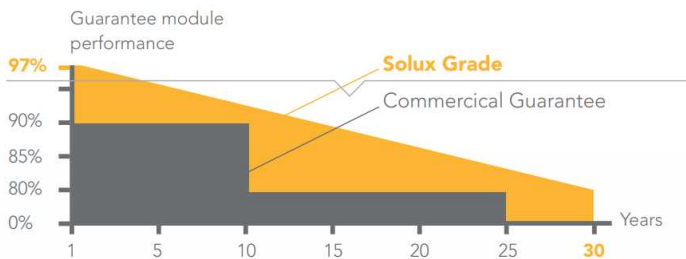

## CONTROLLER MPPT



**+** WATERPROOF CONNECTORS  
"PLUG & PLAY"

All our components are assembled **seamless and easy to access**

In a search for performance and reliability, our products are equipped with MPPT technology controller offering the best charging efficiency on the market up to 98%

### REMOTE CONTROL MONITORING

In order to facilitate all maintenance operations and above all to diagnose any possible problem, without having to intervene mechanically on the luminaire, BULLARD SOLAR luminaires are equipped with a wireless diagnostic system via remote control



**With a simple click it is possible to have real-time information such as:**

- Automatic diagnosis in case of malfunction
- State of charge and battery history
- Real Time load and solar panel energy production history
- Age of the product and installation Temperature and its history

## FEATURES

- Minimal stand-by power consumption
- Current consumption  $\leq 10\text{mA}$
- Intelligent battery management

### 3 Phases charging:

- Charge MPPTT
- Constant voltage
- Floating voltage

- Intelligent LED driver Auto detecting of Dusk and Dawn for automatic operation, 7 Lighting Programs Configuration.
- ANTI BLACK OUT: Load adjust according to battery capacity assuring all night long lighting in any weather conditions.
- The controller also acts against:

- OVERLOAD
- OVERCURREN
- OVERTEMPERATURE
- OVERVOLTAGE / OVERLOAD
- OVERDISCHARGE

### ONE WITH THE SUN

sales@gordonbullard.com  
www.bullardsolar.com  
1-877-964-4646



991 South Gull Lake Dr  
Richland, MI 49083  
USA

FIXTURE TYPE: \_\_\_\_\_

PROJECT NAME: \_\_\_\_\_

# MOTION SENSOR MICROWAVE

Bullard Solar luminaires are equipped with microwave sensors that use the Doppler effect (like car radars) to detect a near-by objects and measure the distance. The sensor emits a high frequency wave to reflect off of and analyze the objects in the vicinity. Since the microwaves only detect specific objects, detection reliability increases resulting in:

- Much better reliability compared to the Infrared sensor
- Up to 360° Directivity
- Insensitivity to other environmental variations such as light, color, temperature, etc.

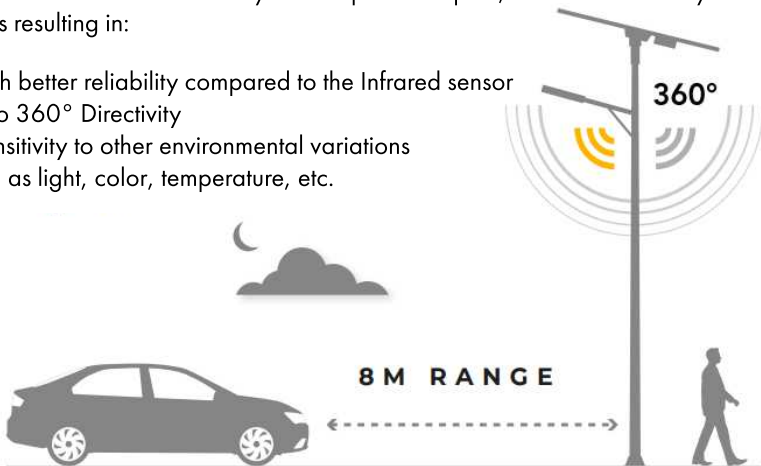

## OPERATION MODE & LIGHTING SCHEDULE

In addition to automatic switching on and off, you have the possibility of choosing among different modular operating modes according to the needs of the project

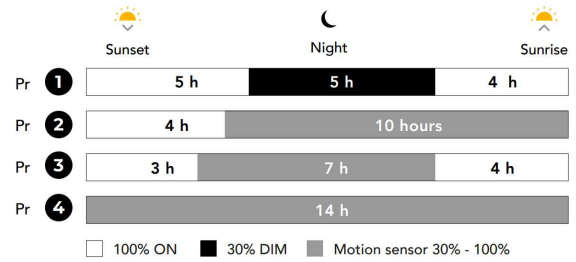

CONTACT US FOR MORE PROGRAM OPTIONS

# BULLARD SOLAR BRIDGE REMOTE MONITORING

As part of his continuous effort for development, the Bullard Solar team is proud to have developed a special tool for remote monitoring of our solar street light. Bullard Solar Bridge uses low frequency technology LORA or ZIGBEE to monitor in real time a batch of solar street lights. YOU CAN NOW MANAGE YOUR SOLAR PARK REMOTELY:

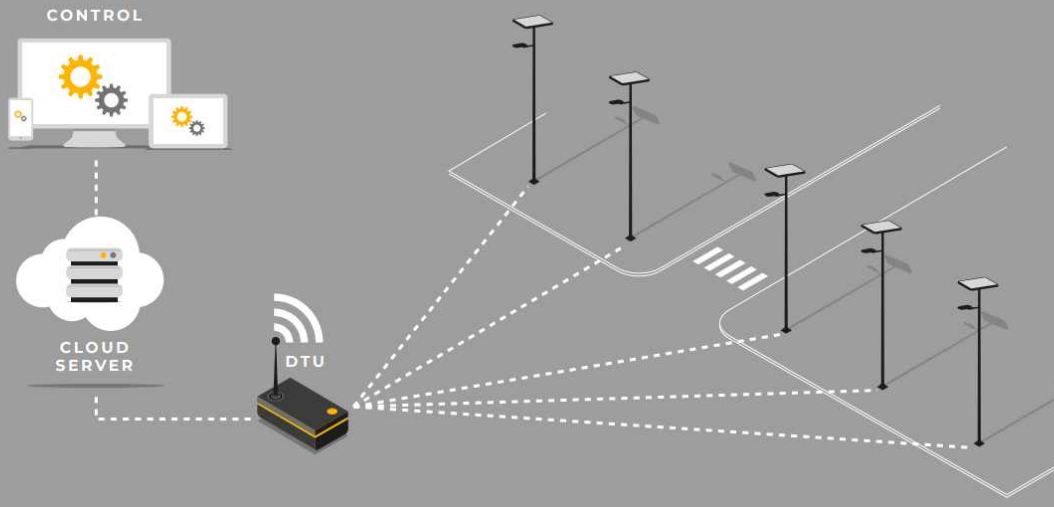

- INTERNET 2G/3G/4G 
- CONNECTION SECURE 
- GREAT RANGE OF COMMUNICATION 
- LOW CONSUMPTION 

ONE WITH THE SUN

sales@gordonbullard.com  
www.bullardsolar.com  
1-877-964-4646



991 South Gull Lake Dr  
Richland, MI 49083  
USA



**BULLARD  
SOLAR**  
One with the Sun

**CODE:  
SP-D**

FIXTURE TYPE: \_\_\_\_\_

PROJECT NAME: \_\_\_\_\_

# EASY INSTALLATION

## NO CABLING | NO TRENCHING

With a well designed bracket support SSLXPRO is effortless and flexible to install. Free 360° rotation of the panel to always face the Sun

**INSERT, ORIENTATE & CHOOSE YOUR TILT**



# DIMENSIONS \*

## SOLAR PANEL & LED

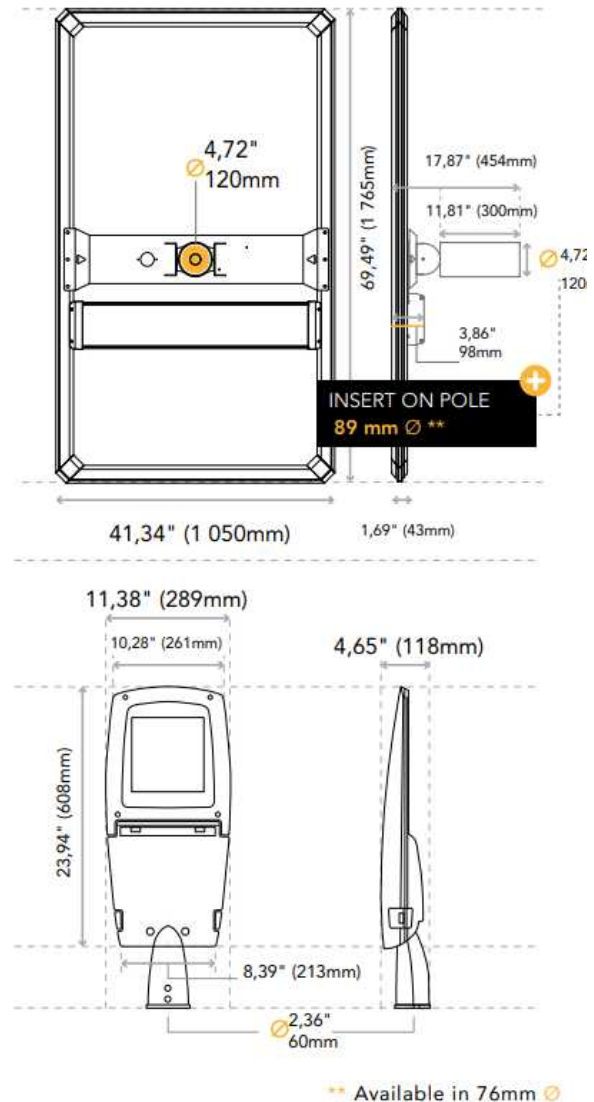
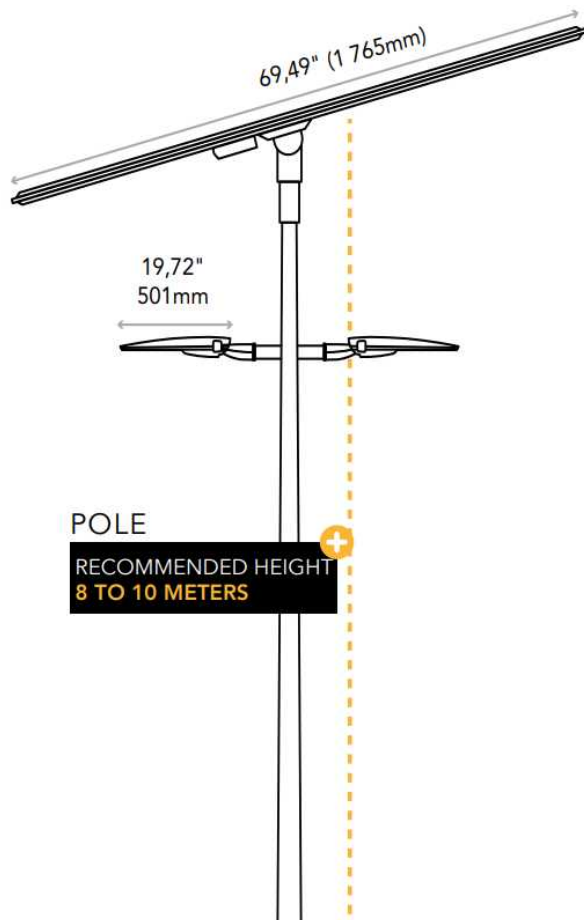

\* All dimensions are in mm

**ONE WITH THE SUN**

sales@gordonbullard.com  
www.bullardsolar.com  
1-877-964-4646



991 South Gull Lake Dr  
Richland, MI 49083  
USA

Due to the dynamic nature of lighting products and the associated technologies, luminaire data on all specification sheets is subject to change at the discretion of Gordon Bullard LLC and associated companies.

© Bullard & Company 2024 All Rights Reserved

Updated 07/09/2024

FIXTURE TYPE: \_\_\_\_\_

PROJECT NAME: \_\_\_\_\_

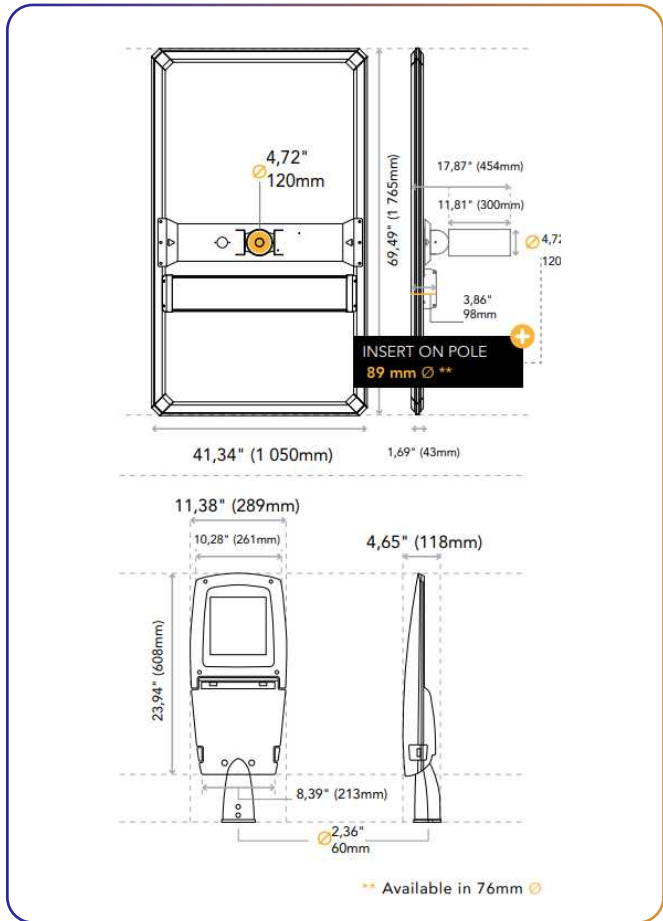
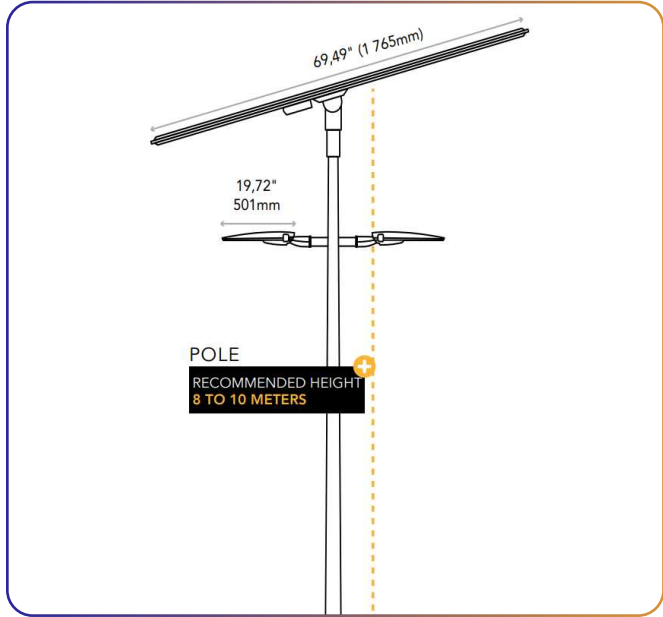

**HOW TO ORDER:**

**CODE:**

**Example:**  
CODE: SP-D-50-BL-23K

SP-D-50-BL-23K

**1 DIMENSIONS:**

-50

(69.69" x 41.73" x 5.91") 177 cm x 106 cm x 15 cm

**2 FINISH OPTIONS:**

-BL

-BL Black

**3 CCT:**

- 23K 2300K
- 30K 3000K
- 40K 4000K
- 50K 5000K
- 65K 6500K

**ONE WITH THE SUN**

sales@gordonbullard.com  
www.bullardsolar.com  
1-877-964-4646



991 South Gull Lake Dr  
Richland, MI 49083  
USA