



**BULLARD  
BOLLARDS**  
Think Bollard Think Bullard

**FLEX 360 R40**  
**BB-FLX360R40-CL**





FIXTURE TYPE: \_\_\_\_\_

PROJECT NAME: \_\_\_\_\_

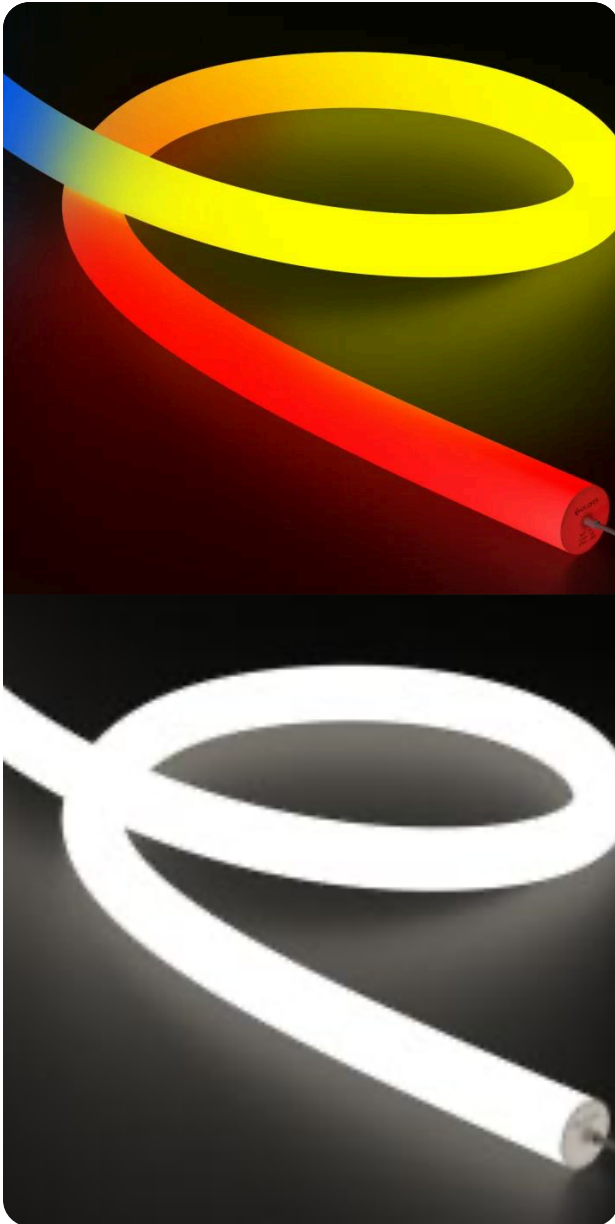

**GENERAL INFORMATION:**

The FLEX 360 Collection is a premium round-profile LED neon flex delivering true 360° omnidirectional illumination. Engineered with advanced silicone extrusion technology, it provides seamless, dot-free light output with consistent brightness from every viewing angle. The flexible construction allows smooth bending and shaping, making it ideal for creative architectural outlines, feature lighting, and decorative installations where uniform circular light distribution is required. Designed for both indoor and outdoor applications, the FLEX 360 series features durable, UV-resistant silicone housing with high ingress protection ratings for long-term reliability. Available in multiple diameters and configurations, including single color, tunable white, RGB, and RGBW options, the system supports various control protocols depending on the model. With high CRI performance, cut-to-length customization, and compatibility with standard LED drivers.

**FIXTURE TYPE:**

360 LED Neon Flexible

**MATERIAL:**

High Purity Silica Gel

**IP RATING:**

IP65

**IP65**

**IK RATING:**

IK08

**IK08**

**WARRANTY:**

LED lighting products are warranted for 5 years.

**DRIVER POSITION:**

Remote

**MAIN FEATURES:**

Full colour RGBW  
Functional and minimalistic design  
Skin-friendly surface treatment  
Operating Temperature: -13°F to +131°F.

**THINK BOLLARD - THINK BULLARD**

sales@gordonbullard.com  
www.bullardbollards.com  
1-877-964-4646



991 South Gull Lake Dr  
Richland, MI 49083  
USA



FIXTURE TYPE: \_\_\_\_\_

PROJECT NAME: \_\_\_\_\_

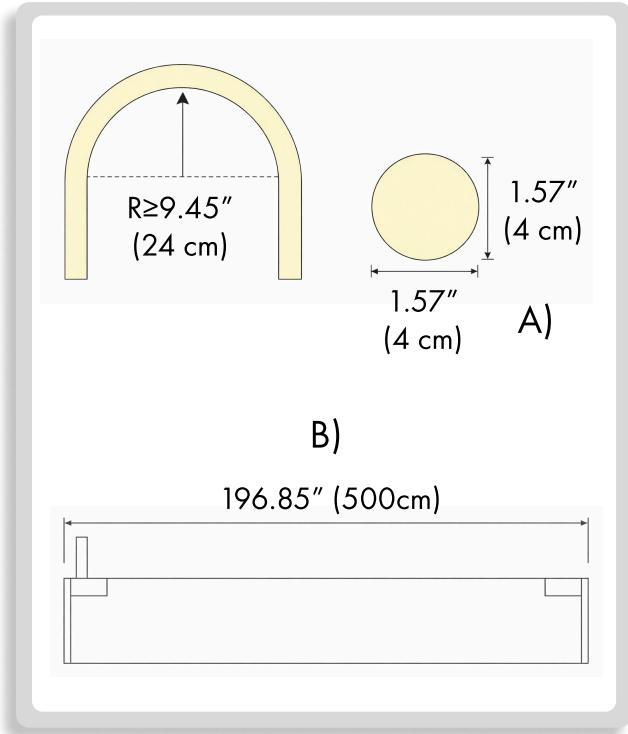

**HOW TO ORDER:**

**CODE:**

**Example:**  
**CODE: BB-FLX360R40-CL-LS1LP-ECT-AS-NNR40VTD-XX-2-AS-NNR40LH/CX-S50A45-402-02-000000-00013-402-02-000000-00001**

**BB-FLX360R40-CL-LS1LP-ECT-AS-NNR40VTD-XX-2-AS-NNR40LH/CX-S50A45-402-02-000000-00013-402-02-000000-00001**

**1 DIMENSIONS:**

A) Diameter -  $\varnothing$ : 1.57'' (4 cm)  
 B) Length - L: 196.85'' (500 cm)

**2 LIGHT SOURCE:**

CODE	INPUT VOLTAGE	CCT	RATED POWER	CRI	LUMENS	CUTTING
-LS1LP -LS2LP -LS3LP -LS4LP	24VDC	2300 K	15W (4.6W/ft)	90	1110 (338.41/ft)	No cutting 14LED/1.64''
		2700 K			1260 (384.15/ft)	
		3000 K			1310(399.39/ft)	
		4200 K			1310(399.39/ft)	
-LS1HP -LS2HP -LS3HP -LS4HP	24VDC	2300 K	18W (5.5W/ft)	90	1890(576.22/ft)	No cutting 16LED/1.97''
		2700 K			2050(625.00/ft)	
		3000 K			2090(637.20/ft)	
		4200 K			2105(641.77/ft)	
-LS1RGB	24VDC	RGB	14.4W (4.4W/ft)	/	445(135/67/ft)	No cutting 14LED/1.97''
-LS1RGBW -LS2RGBW -LS3RGBW -LS4RGBW		RGB-2300 K	17.2W (5.2W/ft)	/	775(236.28/ft)	No cutting 24LED/2.46''
		RGB-2700 K			895(272.87/ft)	
		RGB-3000 K			930(283.54/ft)	
	RGB-4200 K	895(272.87/ft)				
-LS1SPI	12VDC	SPI	21.6W (5.2W/ft)	/	280(85.37/ft)	Arbitrary cutting 2LED/0.4'' IC:(WS2815) 90Pixels/m

**3 ENTRY CABLE:**

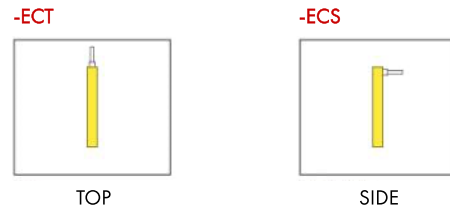

**THINK BOLLARD - THINK BULLARD**

sales@gordonbullard.com  
 www.bullardbollards.com  
 1-877-964-4646



991 South Gull Lake Dr  
 Richland, MI 49083  
 USA



FIXTURE TYPE: \_\_\_\_\_

PROJECT NAME: \_\_\_\_\_

**HOW TO ORDER:**

**CODE:**

**Example:**  
CODE: BB-FLX360R40-CL-LS1LP-ECT-AS-NNR40VTD-XX-2-AS-NNR40LH/CX-S50A45-402-02-000000-00013-402-02-000000-00001

BB-FLX360R40-CL-LS1LP-ECT-AS-NNR40VTD-XX-2-AS-NNR40LH/CX-S50A45-402-02-000000-00013-402-02-000000-00001

**4 ACCESSORIES:**

**-AS-NNR40VTD-XX-2**

R40 Trimless embedded accessory



**-AS-NNR40VRD-XX-2**

R40 Embedded accessory



**-AS-NNR40P1-25**

R40 N-buckle accessory



**-AS-NNR40LCX-1000**

R40 N-groove accessory



**-AS-NNR40DCX-XX**

R40 Invisible buckle

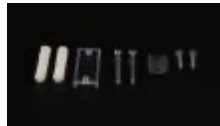

**-AS-NNR40VCC-XX-2**

R40 Ceiling mounting accessory



**-AS-NNR40GHO-EC**

R40 Hole Diameter 4.5mm top cap



**-AS-NNR40GS0-EC**

R40 Hole Diameter 4.5mm side cap



**-AS-NNR40GH1-EC**

R40 Hole Diameter 5.6mm top cap



**-AS-NNR40GS1-EC**

R40 Hole Diameter 5.6mm side cap



**-AS-NNR40LHX-S2000**

R40 Lifting accessories



**AS-NNR40LCX-0070SW**

R40 Splicing accessories



**-AS-NNR40LH/CX-0500**

0.5m linear profiles  
L500\*W21\*H12.2mm



**-AS-NNR40LH/CX-1000**

1m linear profiles  
L1000\*W21\*H12.2mm



**-AS-NNR40LH/CX-S50A45**

φ500mm side-bending 45° profile  
φ500\*21\*12.2mm



**-AS-NNR40LH/CX-S50A90**

φ500mm side-bending 90° profile  
φ500\*21\*12.2mm



**THINK BOLLARD - THINK BULLARD**

sales@gordonbullard.com  
www.bullardbollards.com  
1-877-964-4646



991 South Gull Lake Dr  
Richland, MI 49083  
USA



FIXTURE TYPE: \_\_\_\_\_

PROJECT NAME: \_\_\_\_\_

**HOW TO ORDER:**

**CODE:**

**Example:**  
CODE: BB-FLX360R40-CL-LS1LP-ECT-AS-NNR40VTD-XX-2-AS-NNR40LH/CX-S50A45-402-02-000000-00013-402-02-000000-00001

BB-FLX360R40-CL-LS1LP-ECT-AS-NNR40VTD-XX-2-AS-NNR40LH/CX-S50A45-402-02-000000-00013-402-02-000000-00001

**4 ACCESSORIES:**

**-AS-NNR40LH/CX-S50A120**

φ500mm side-bending 120° profile  
φ500\*21\*12.2mm

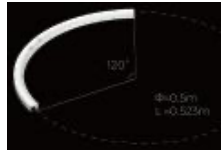

**-AS-NNR40LH/CX-S50A180**

φ500mm side-bending 180° profile  
φ500\*21\*12.2mm

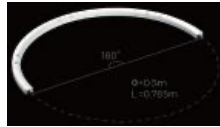

**-AS-NNR40LH/CX-T050A90**

φ500mm upward bending 90° profile  
φ500\*21\*12.2mm



**-AS-NNR40LH/CX-D050A90**

φ500mm downward bending 90° profile  
φ500\*21\*12.2mm



**-AS-NNR40LH/CX-S100A45**

φ1000mm side-bending 45° profile  
φ1000\*21\*12.2mm



**-AS-NNR40LH/CX-S100A90**

φ1000mm side-bending 90° profile  
φ1000\*21\*12.2mm



**-AS-NNR40LH/CX-S100A120**

φ1000mm side-bending 120° profile  
φ1000\*21\*12.2mm

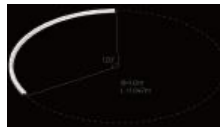

**-AS-NNR40LH/CX-T100A90**

φ1000mm upward bending 90° profile  
φ1000\*21\*12.2mm



**-AS-NNR40LH/CX-D100A90**

φ1000mm downward bending 90° profile  
φ1000\*21\*12.2mm

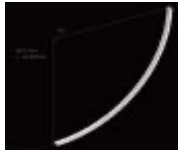

**-AS-NNR40LH/CX-S150A45**

φ1500mm side-bending 45° profile  
φ1500\*21\*12.2mm



**-AS-NNR40LH/CX-S150A90**

φ1500mm side-bending 90° profile  
φ1500\*21\*12.2mm



**5 SYSTEM CONTROL:**

**-402-02-000000-00001**

Monochrome Remote Control  
R6-1  
Operating voltage: 3VDC(Battery CR2032)  
Operating frequency: 2.4GHz  
Remote control distance: 30m  
Operating temperature: -30°C-55°C  
Size:L107\*W58.5\*H9(mm)



**-402-0-000000-00013**

Knob panel controller used for dimming to warm  
CP1-GBB  
Input voltage: 12-24VDC  
Input current: 6A\*1CH  
Operating temperature: -30°C-55°C  
Size: L86\*W86\*H33(mm)



**THINK BOLLARD - THINK BULLARD**

sales@gordonbullard.com

www.bullardbollards.com

1-877-964-4646



991 South Gull Lake Dr

Richland, MI 49083

USA

FIXTURE TYPE: \_\_\_\_\_

PROJECT NAME: \_\_\_\_\_

**HOW TO ORDER:**

**CODE:**

**Example:**  
CODE: BB-FLX360R40-CL-LS1LP-ECT-AS-NNR40VTD-XX-2-AS-NNR40LH/CX-S50A45-402-02-000000-00013-402-02-000000-00001

BB-FLX360R40-CL-LS1LP-ECT-AS-NNR40VTD-XX-2-AS-NNR40LH/CX-S50A45-402-02-000000-00013-402-02-000000-00001

**5 SYSTEM CONTROL:**

**-402-02-000000-00013**

Monochrome Control Receiver  
CR1-GBA

Input voltage: 12-48VDC  
Maximum load current: 15A\*1CH, Max 15A@12/24V  
10A \*1CH, Max 10A@36/48V  
Maximum load power: 15A\*1CH, Max 15A@12/24V  
10A \*1CH, Max 10A@36/48V  
Operating temperature: -30°C-55°C  
Size: L175\*W45\*H27(mm)



**-402-02-000000-00013**

RGBW Control Receiver  
CR4-GBA  
Input voltage: 12-48VDC  
Maximum load current: 5A\*4CH, Max 20A  
Maximum load power: 240W/480W@12V/24V  
720W/960W@36V/48V  
Operating temperature: -30°C-55°C  
Product Size: L175\*W45\*H27(mm)



**-402-02-000000-00003**

RGB/RGBW Remote Control  
R8-1

Operating voltage: 3VDC (Battery CR2032)  
Operating frequency: 2.4GHz  
Remote control distance: 30m  
Operating temperature: -30°C-55°C  
Product Size: L107\*W58.5\*H9(mm)



**-23-01-00-0048**

Programcontrolled digital controller  
K-1000C  
Operating temperature: -30°C 85°C  
Power supply: direct current 5V-24V input  
Power consumption: 2W  
Data transferring port: 1 (1\*1024 pixel)  
Weight : 0.35 Kg  
Product size: L159\*W89\*H24mm  
Storage type: SD card  
Capacity of storage card: 128MB-32GB  
Storage format: FAT or FAT32  
Storage file: \*.led



**-402-01-000000-00003**

RGB Control Receiver  
CR3-GBA

Input voltage: 12-48VDC  
Maximum load current: 6A\*3CH, Max 18A  
Maximum load power: 216W/432W@12V/24V  
648W/864@36V/48V  
Operating temperature: -30°C-55°C  
Size: L175\*W45\*H27(mm)



**THINK BOLLARD - THINK BULLARD**

sales@gordonbullard.com  
www.bullardbollards.com  
1-877-964-4646



991 South Gull Lake Dr  
Richland, MI 49083  
USA

FIXTURE TYPE: \_\_\_\_\_

PROJECT NAME: \_\_\_\_\_

**HOW TO ORDER:**

**CODE:**

**Example:**  
CODE: BB-FLX360R40-CL-LS1LP-ECT-AS-NNR40VTD-XX-2-AS-NNR40LH/CX-S50A45-402-02-000000-00013-402-02-000000-00001

BB-FLX360R40-CL-LS1LP-ECT-AS-NNR40VTD-XX-2-AS-NNR40LH/CX-S50A45-402-02-000000-00013-402-02-000000-00001

**5 SYSTEM CONTROL:**

**-23-01-00-0050**

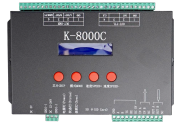

Programmable digital controller  
K-8000C  
Operating temperature: -20°C-85°C  
Operating power supply: DC5V-24V input  
Power consumption: 5W  
Data transfer ports: 8 (8\*1024 pixel)  
Weight: 0.8 kg  
Size: L180\*W120\*H30mm  
Memory card: SD card  
Storage capacity: 128MB-32GB  
Card format: FAT/FAT32  
Storage file: \*.led

**-23-01-00-0041**



Input voltage: 5-24V  
Output voltage: 50W/120W/240W(5V/12V/24V)  
Output power: 50W/120W/240W(5V/12V/24V)  
Output current: 10A  
Dimming mode: SPI remote control  
Wireless signal: 2.4GHz  
IP: IP20  
Operating temperature: -30°C-55°C  
Product size: L104×W58×H9(mm)

**THINK BOLLARD - THINK BULLARD**

sales@gordonbullard.com  
www.bullardbollards.com  
1-877-964-4646



991 South Gull Lake Dr  
Richland, MI 49083  
USA