



**BULLARD
BOLLARDS**
Think Bollard Think Bullard



ILLUMINATED FURNITURE

INSTALLATION TYPE:
SURFACE-MOUNT



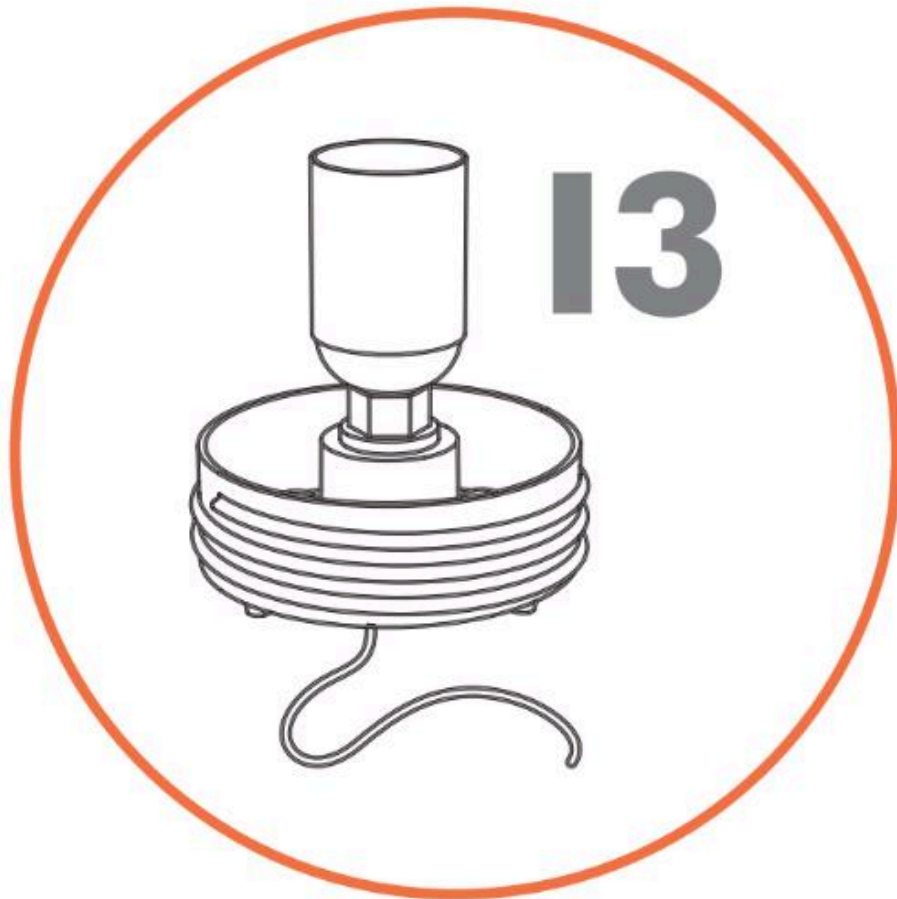

13
BASE MODEL

BULB REPLACEMENT

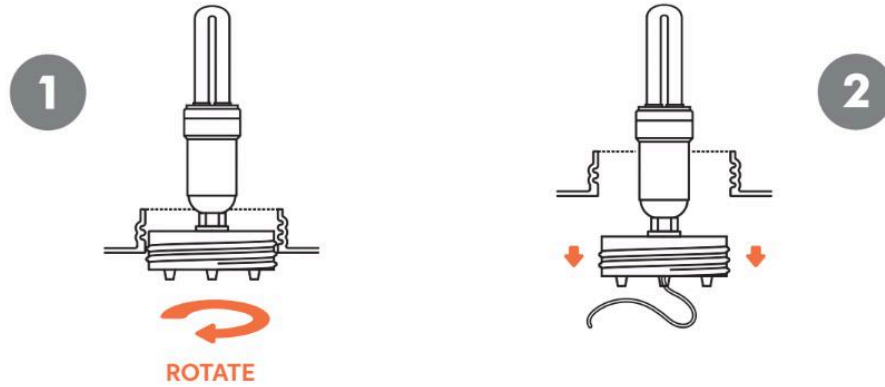

SYSTEM FOR FLOOR/WALL MOUNTING

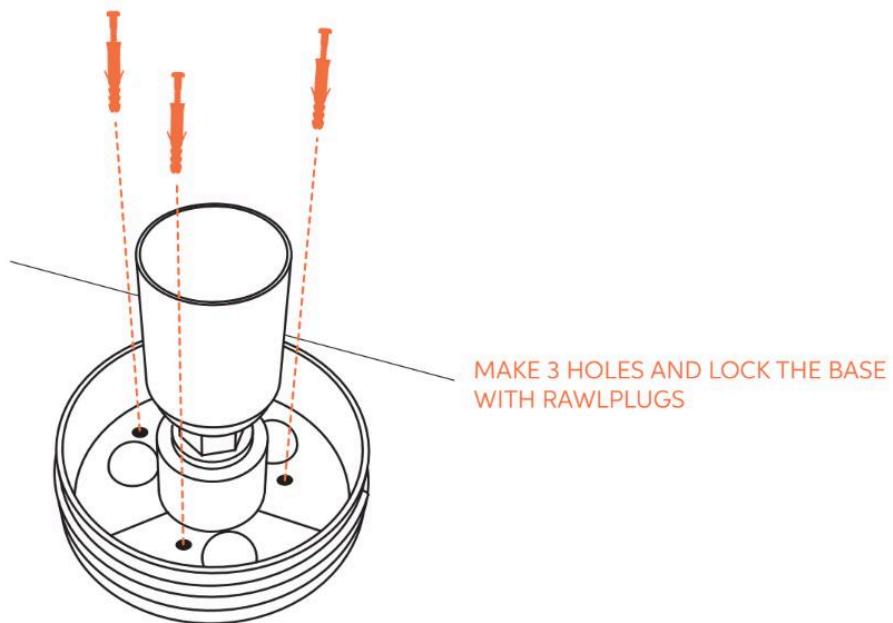

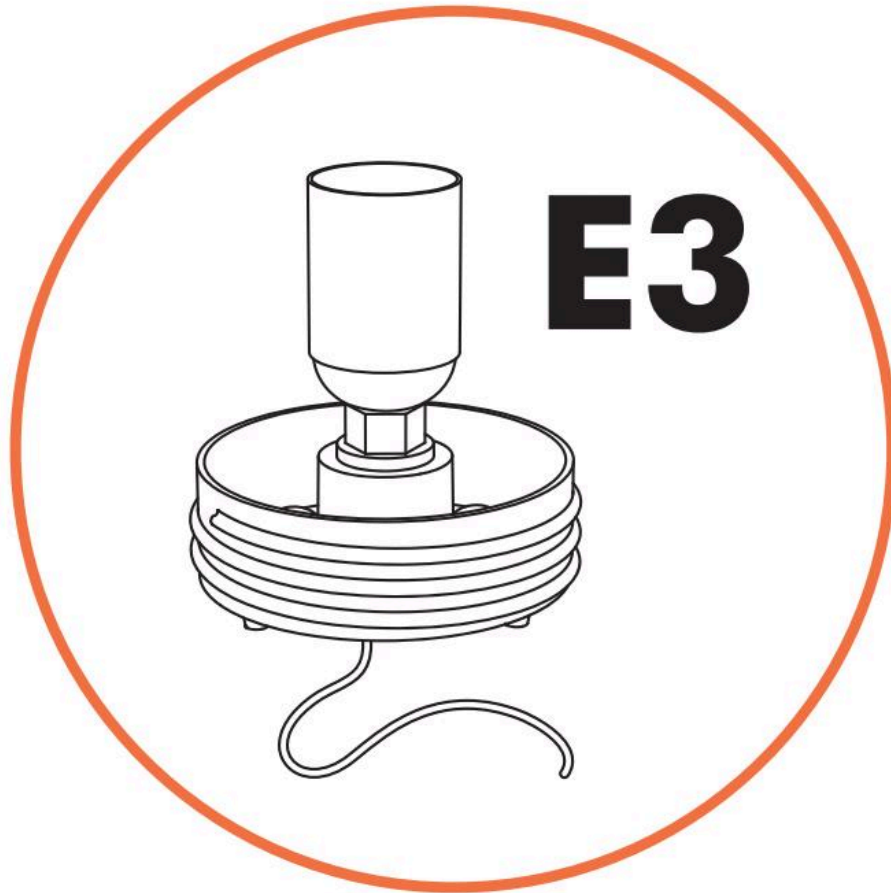

E3
BASE MODEL

P.2

sales@gordonbullard.com
www.bullardbollards.com
1 877-964-4646



991 South Gull Lake Dr.
Richland, MI 49083
USA

BULB REPLACEMENT

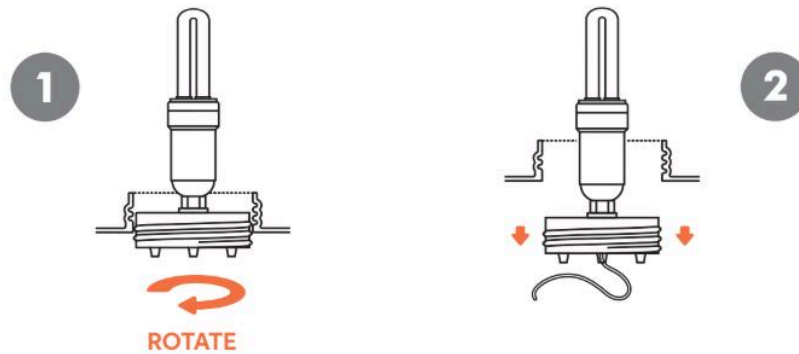

SYSTEM FOR FLOOR/WALL MOUNTING*

MAKE 3 HOLES AND LOCK THE BASE WITH RAWLPLUGS

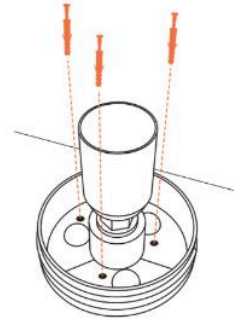

Warning: this operation could modify the degree of the waterproof protection (IP55). BULLARD BOLLARDS assumes no responsibility for any possible malfunction of the product. It is recommended to seal the holes with silicone sealant to prevent the passage of liquids.

EARTH SPIKE POSITIONING**



** Earth spike not included. It must be ordered separately.



CANDY LIGHT
INFRARED RGBW LED MODULE

P.2

sales@gordonbullard.com
www.bullardbollards.com
1 877-964-4646



991 South Gull Lake Dr.
Richland, MI 49083
USA

CANDY LIGHT MODULE PLACEMENT

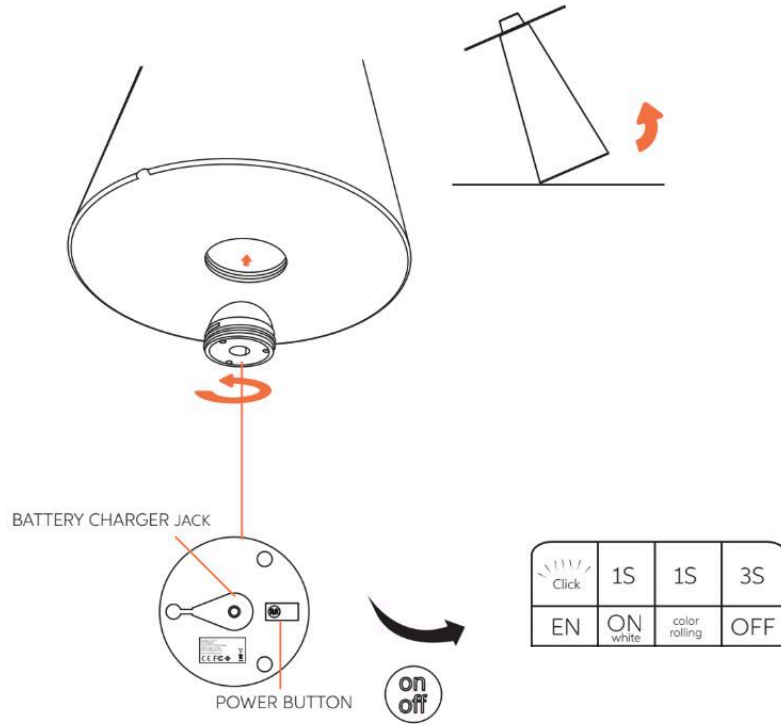

CANDY LIGHT REMOTE CONTROL

