



**BULLARD
BOLLARDS**
Think Bollard Think Bullard

CORRIMANO
(ARCHITECTURAL SOLUTIONS)



FIXTURE TYPE: _____

PROJECT NAME: _____

NOTES:

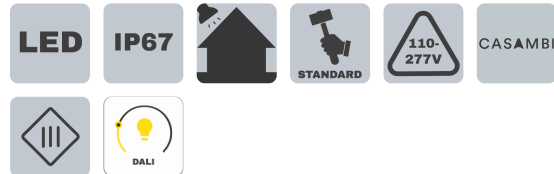

GENERAL INFORMATION:

The Bullard Bollards BB-001108.BGXO-GH is a sleek, architectural-grade LED handrail luminaire engineered for durability, performance, and refined aesthetics. Designed for recessed applications, this IP67-rated fixture features an extruded EN AW-6060 T5 aluminum body with anodized finish, stainless steel A4 hardware, silicone gaskets, and an anti-UV technopolymer lens for long-lasting performance in demanding environments. Operating on 24V DC with high visual comfort optics (122° light distribution, CRI >90), it delivers consistent, energy-efficient illumination in multiple color temperatures (2700K–4000K). With fixed optics, remote driver compatibility, and a wide range of mounting accessories, the BB-001108.BGXO-GH is ideal for architectural handrails, pathways, and public spaces requiring minimal design, shock resistance, and reliable performance in temperatures from -22°F to 122°F.

LIGHTING:

LED 

VOLTAGE:

110-277V 

GASKETS:

Silicone gaskets

FIXTURE TYPE:

Architectural Solutions

MATERIAL:

Extruded aluminum EN AW-6060 T5 high resistance to oxidation

EXTERNAL SCREWS:

Stainless Steel A4

DIFFUSER MATERIAL:

Silicone

IP RATING:

IP 67 

APPLINCE CLASS:

|||

THINK BOLLARD - THINK BULLARD

sales@gordonbullard.com
www.bullardbollards.com
1-877-964-4646



991 South Gull Lake Dr
Richland, MI 49083
USA

FIXTURE TYPE: _____

PROJECT NAME: _____

NOTES:

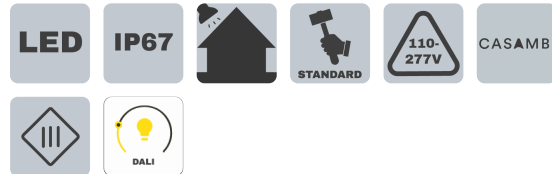

OPERATION RANGE:

24 V DC

DRIVER POSITION:

Remote

CRI:

>90

CABLE ENTRY / CABLE TYPE:

Cable gland PE-LD 5.2mm / FR5FOEM7-AD8 2x0.5mm²

CORD LENGTH:

0.5m

LIGHT DISTRIBUTION:

122°

BEAM DIRECTIONABILITY:

Fixed optics

OPTICS:

Anti UV technopolymer lens

WARRANTY:

LED lighting products are warranted for 5 years.

MAIN FEATURES:

High visual comfort / Wide range of finishes
Functional design / Minimal design
Shock resistant / Operating Temperature: -22°F~122°F

FINISH OPTIONS:

Anodized

THINK BOLLARD - THINK BULLARD

sales@gordonbullard.com
www.bullardbollards.com
1-877-964-4646



991 South Gull Lake Dr
Richland, MI 49083
USA



FIXTURE TYPE: _____

PROJECT NAME: _____

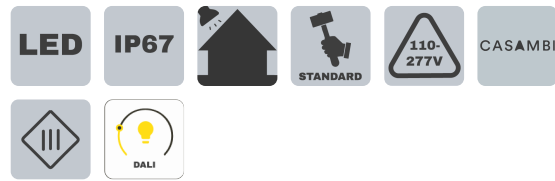
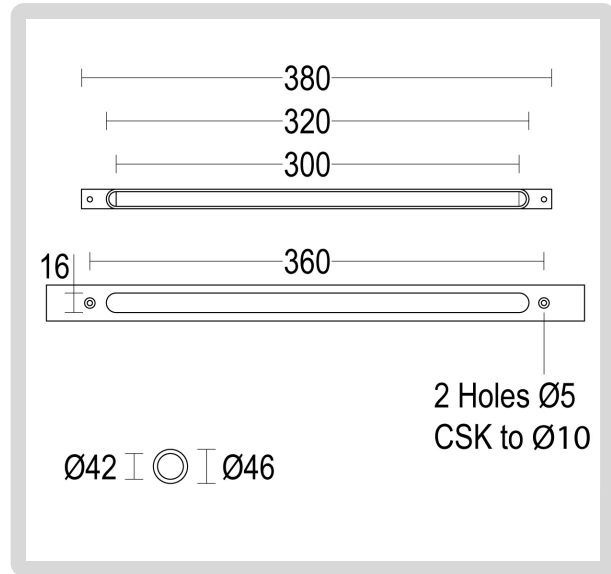

HOW TO ORDER:

CODE:

Example:
CODE: BB-001108.BGXO-GH-400-1-L2
-AC140-AC219

BB-001108.BGXO-
GH-400-1-L2
-AC140-AC219

1 MODELS:

-400-1

- A) Recessed depth - Ø: " (1.6 cm)
- B) Length - L: " (42 cm)
- C) Width - W: " (1.6 cm)

2 LIGHT SOURCE:

CODE WATTAGE | KELVINS | LUMENS

- L1 1 x 2.88W | 2700K | 1 x 213 lm | 24 V DC
- L2 1 x 2.88W | 3000K | 1 x 222 lm | 24 V DC
- L3 1 x 2.88W | 4000K | 1 x 207 lm | 24 V DC

3 DIMMING OPTIONS:

- NON NON-Dimmable
- DIM 0-10V
- CAS Casambi
- DAL Dali

4 ACCESSORIES:

-AC139 Pair of anti-vandal screws	-AC214 Ground anchorage base	-AC218 90° Joint	-AC255 Glass anchor with angle bracket
-AC140 Vandal proof wrench	-AC215 Wall anchorage	-AC219 Cap for handrail tube	-AC318 Handrail support
-AC223 Special glue or component cod. 214, 216, 217, 218	-AC216 Joint for extension	-AC221 Pre-cut handrail 800mm	
-AC213 Wall anchor with angle bracket	-AC217 Orientable junction	-AC222 Blind handrail tube 1000mm	

THINK BOLLARD - THINK BULLARD

sales@gordonbullard.com
www.bullardbollards.com
1-877-964-4646



991 South Gull Lake Dr
Richland, MI 49083
USA

FIXTURE TYPE: _____

PROJECT NAME: _____

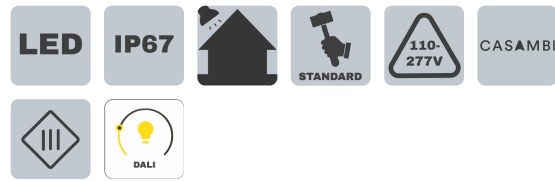
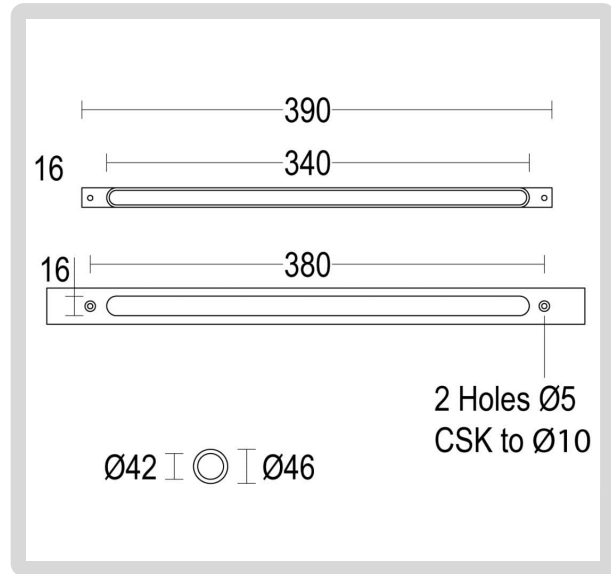

HOW TO ORDER:

CODE:

Example:
CODE: BB-001108.BG XO-GH-400-1-L2
-AC140-AC219

BB-001108.BG XO-
GH-400-1-L2
-AC140-AC219

1 MODELS:

-400-2

- A) Recessed depth - Ø: " (1.6 cm)
- B) Length - L: " (42 cm)
- C) Width - W: " (1.6 cm)

2 LIGHT SOURCE:















CODE | WATTAGE | KELVINS | LUMENS

- L1** 1 x 4.35W | 3000K | 1 x 519 lm | 24 V DC
- L2** 1 x 4.35W | 4000K | 1 x 571 lm | 24 V DC

3 DIMMING OPTIONS:

- NON** NON-Dimmable
- DIM** 0-10V
- CAS** Casambi
- DAL** Dali

4 ACCESSORIES:

-AC139 Pair of anti-vandal screws		-AC214 Ground anchorage base		-AC218 90° Joint		-AC255 Glass anchor with angle bracket	
-AC140 Vandal proof wrench		-AC215 Wall anchorage		-AC219 Cap for handrail tube		-AC318 Handrail support	
-AC223 Special glue or component cod. 214, 216, 217, 218		-AC216 Joint for extension		-AC221 Pre-cut handrail 800mm			
-AC213 Wall anchor with angle bracket		-AC217 Orientable junction		-AC222 Blind handrail tube 1000mm			

THINK BOLLARD - THINK BULLARD

sales@gordonbullard.com
www.bullardbollards.com
1-877-964-4646



991 South Gull Lake Dr
Richland, MI 49083
USA

FIXTURE TYPE: _____

PROJECT NAME: _____

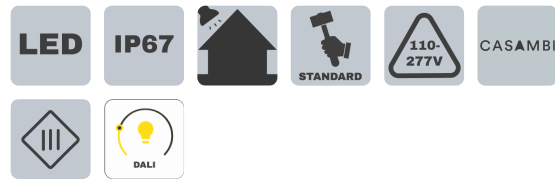
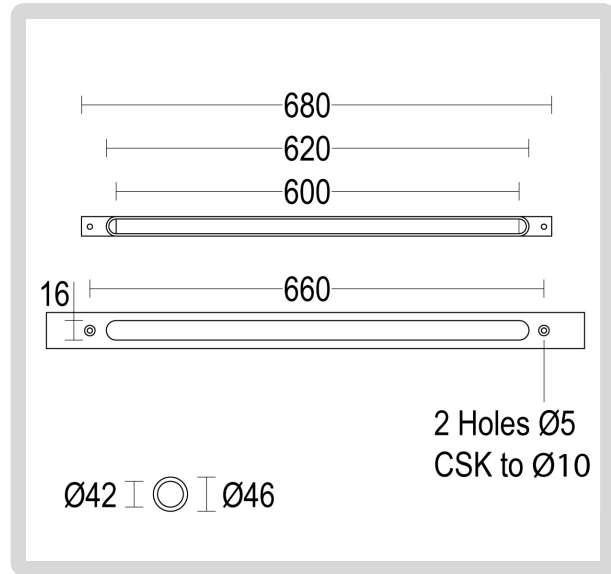

HOW TO ORDER:

CODE:

Example:
CODE: BB-001108.BGXO-GH-400-1-L2
-AC140-AC219

BB-001108.BGXO-
GH-400-1-L2
-AC140-AC219

1 MODELS:

-700

- A) Recessed depth - Ø: " (1.6 cm)
- B) Length - L: " (70 cm)
- C) Width - W: " (1.6 cm)

2 LIGHT SOURCE:











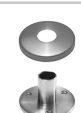

CODE WATTAGE | KELVINS | LUMENS

- L1 1 x 5.76W | 2700K | 1 x 426 lm | 24 V DC
- L2 1 x 5.76W | 3000K | 1 x 444 lm | 24 V DC
- L3 1 x 5.76W | 4000K | 1 x 414 lm | 24 V DC

3 DIMMING OPTIONS:

- NON NON-Dimmable
- DIM 0-10V
- CAS Casambi
- DAL Dali

4 ACCESSORIES:

-AC139 Pair of anti-vandal screws		-AC214 Ground anchorage base		-AC218 90° Joint		-AC255 Glass anchor with angle bracket	
-AC140 Vandal proof wrench		-AC215 Wall anchorage		-AC219 Cap for handrail tube		-AC318 Handrail support	
-AC223 Special glue or component cod. 214, 216, 217, 218		-AC216 Joint for extension		-AC220 Pre-cut handrail 1500mm			
-AC213 Wall anchor with angle bracket		-AC217 Orientable junction		-AC222 Blind handrail tube 1000mm			

THINK BOLLARD - THINK BULLARD

sales@gordonbullard.com
www.bullardbollards.com
1-877-964-4646



991 South Gull Lake Dr
Richland, MI 49083
USA