



**BULLARD  
BOLLARDS**  
Think Bullard Think Bullard

**FLEX 360 R18**  
BB-FLX360R18-CL





FIXTURE TYPE: \_\_\_\_\_

PROJECT NAME: \_\_\_\_\_

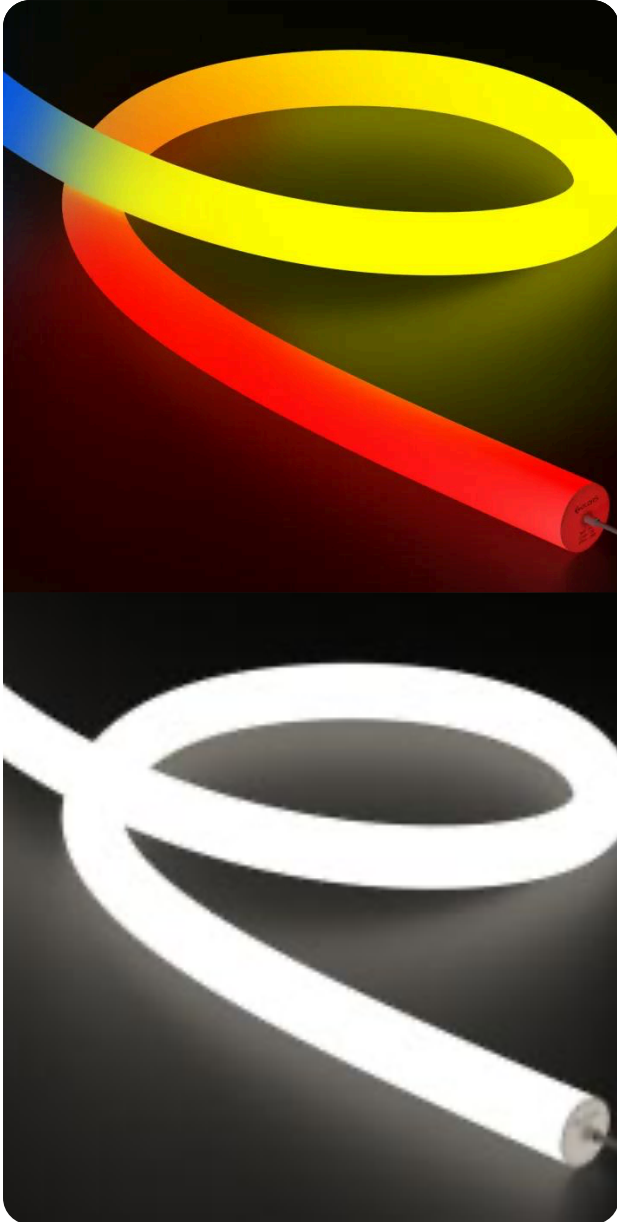

**GENERAL INFORMATION:**

The FLEX 360 Collection is a premium round-profile LED neon flex delivering true 360° omnidirectional illumination. Engineered with advanced silicone extrusion technology, it provides seamless, dot-free light output with consistent brightness from every viewing angle. The flexible construction allows smooth bending and shaping, making it ideal for creative architectural outlines, feature lighting, and decorative installations where uniform circular light distribution is required. Designed for both indoor and outdoor applications, the FLEX 360 series features durable, UV-resistant silicone housing with high ingress protection ratings for long-term reliability. Available in multiple diameters and configurations, including single color, tunable white, RGB, and RGBW options, the system supports various control protocols depending on the model. With high CRI performance, cut-to-length customization, and compatibility with standard LED drivers.

**FIXTURE TYPE:**

360 LED Neon Flexible

**MATERIAL:**

High Purity Silica Gel

**IP RATING:**

IP65

**IP65**

**IK RATING:**

IK08

**IK08**

**WARRANTY:**

LED lighting products are warranted for 5 years.

**DRIVER POSITION:**

Remote

**MAIN FEATURES:**

- Full colour RGBW
- Functional and minimalistic design
- Skin-friendly surface treatment
- Operating Temperature: -13°F to +131°F.

**THINK BOLLARD - THINK BULLARD**

sales@gordonbullard.com  
www.bullardbollards.com  
1-877-964-4646



991 South Gull Lake Dr  
Richland, MI 49083  
USA



FIXTURE TYPE: \_\_\_\_\_

PROJECT NAME: \_\_\_\_\_

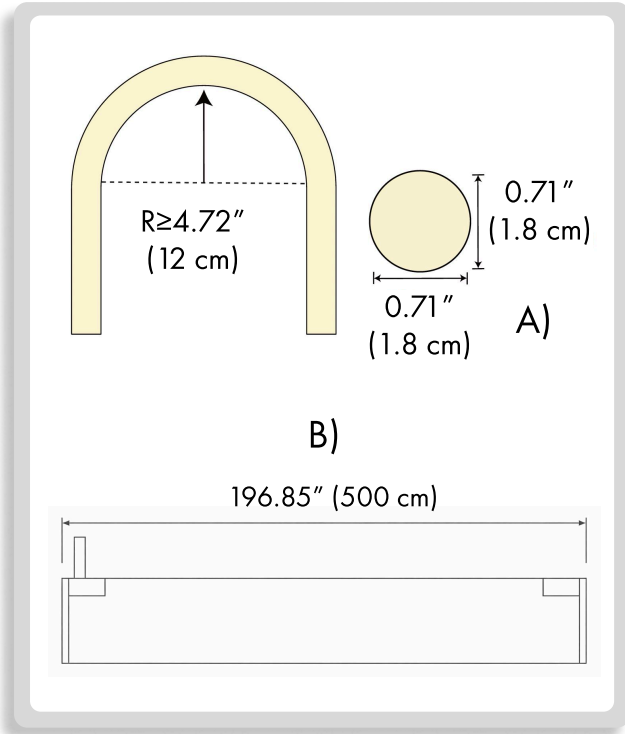

**HOW TO ORDER:**

**CODE:**

Example:  
CODE: BB-FLX360R18-CL-LS1-ECT-AS-NNR18VTD-  
XX-2-402-02-000000-00001-402-02-000000-00013

BB-FLX360R18-CL-  
LS1-ECT-AS-  
NNR18VTD-  
XX-2-402-02-00000  
0-00001-402-02-00  
0000-00013

**1 DIMENSIONS:**

A) Diameter - Ø: 0.98" (2.5 cm)  
B) Length - L: 196.85" (500 cm)

**2 LIGHT SOURCE:**

CODE	INPUT VOLTAGE	CCT	RATED POWER	CRI	LUMENS	CUTTING
-LS1	24VDC	2300 K	14.4W (4.39W/ft)	90	700 (213LM/ft)	Arbitrary cutting
-LS2		2700 K			700 (213LM/ft)	
-LS3		3000 K			800 (244LM/ft)	
-LS4		4000 K			800 (244LM/ft)	
-LS1G		Green	10W (3.05W/ft)	/	/	2*7LED/1.64"
-LS2B	Blue					
-LS1CCT		2300K-4000K	14.4W (4.39W/ft)	90	850 (259LM/ft)	2*12LED/1.23"
-LS1RGB		RGB	13W (3.96W/ft)	/	/	2*7LED/1.97"

**3 ENTRY CABLE:**

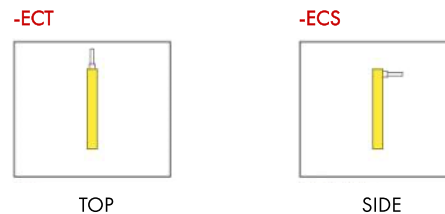

**THINK BOLLARD - THINK BULLARD**

sales@gordonbullard.com  
www.bullardbollards.com  
1-877-964-4646



991 South Gull Lake Dr  
Richland, MI 49083  
USA



FIXTURE TYPE: \_\_\_\_\_

PROJECT NAME: \_\_\_\_\_

**HOW TO ORDER:**

**CODE:**

**Example:**  
CODE: BB-FLX360R18-CL-LS1-ECT-AS-NNR18VTD-  
XX-2-402-02-000000-00001-402-02-000000-00013

BB-FLX360R18-CL-  
LS1-ECT-AS-  
NNR18VTD-  
XX-2-402-02-00000  
0-00001-402-02-00  
0000-00013

**4 ACCESSORIES:**

**-AS-NNR18VTD-XX-2**

Trimless embedded accessory



**-AS-NNR18VRD-XX-2**

Embedded accessory



**-AS-NNR13DCX-XX**

Stealth accessories



**-AS-NNR18GH0-EC**

Hole Diameter 4.5mm top cap



**-AS-NNR18GS0-EC**

Hole Diameter 4.5mm side cap



**-AS-FC-0001**

2PIN  
IP68 Quick  
Waterproof  
Connector

**-AS-FC-0002**

3PIN  
IP68 Quick  
Waterproof  
Connector

**-AS-FC-0003**

4PIN  
IP68 Quick  
Waterproof  
Connector



**-AS-NNRSS0-CM**

Cutting Fixture



**-AS-NNR18CCXS-B-4/3**

Woven material  
Ø115\*H34mm with screws



**-AS-NNR18CCXM-B-4/3**

Woven material  
Ø150\*H21mm with screws



**-AS-NNR18CCXL-B-4/3**

Woven material  
Ø175\*H21mm with screws



**-AS-NNR25C-053**

Woven material  
Size:Ø34\*H46mm



**-AS-NNR18C-076**

Woven material  
Size:Ø34\*H76mm



**-AS-NNR18P-1000**

Flat mounting PC groove  
L1000\*W17.1\*H16.3mm

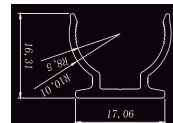

**-AS-NNR18P-60**

Flat mounting PC groove  
1PCS/0.5m

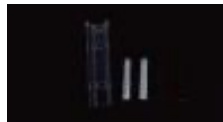
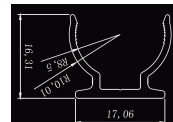

**-AS-NNR18P1-25**

Flat mounting PC groove  
3PCS/1m; 5PCS/2.5m  
8PCS/5m



**THINK BOLLARD - THINK BULLARD**

sales@gordonbullard.com  
www.bullardbollards.com  
1-877-964-4646



991 South Gull Lake Dr  
Richland, MI 49083  
USA

FIXTURE TYPE: \_\_\_\_\_

PROJECT NAME: \_\_\_\_\_

**HOW TO ORDER:**

**CODE:**

**Example:**  
CODE: BB-FLX360R18-CL-LS1-ECT-AS-NNR18VTD-  
XX-2-402-02-000000-00001-402-02-000000-00013

BB-FLX360R18-CL-  
LS1-ECT-AS-  
NNR18VTD-  
XX-2-402-02-00000  
0-00001-402-02-00  
0000-00013

**4 ACCESSORIES:**

**-AS-NNR18VHS1-1000**  
Vertical hanging side outlet  
Install accessory kit (1 m)

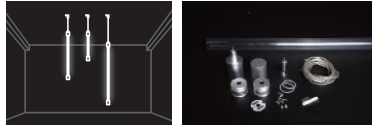

**-AS-NNR25VHS1-2500**  
Vertical hanging side outlet  
Install accessory kit (2.5m)

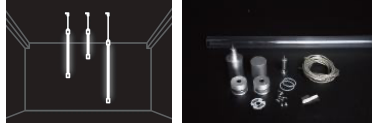

**-AS-NNR18VHD1-1000**  
Hang the top vertically outlet  
Install accessory kit (1 m)

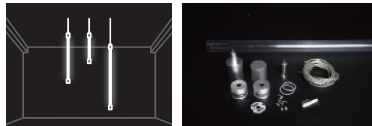

**-AS-NNR18VHD1-2500**  
Vertical hanging from the top  
Install accessory kit (2.5m)



**-AS-NNR18VCC1-1000**  
Single-ended vertical ceiling  
Install accessory kit (1 m)

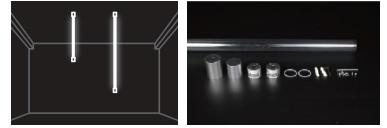

**-AS-NNR18VCC1-2500**  
Single-ended vertical ceiling  
Install accessory kit (2.5m)

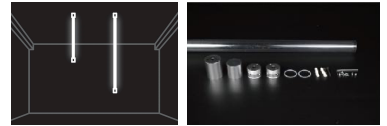

**-AS-NNR18VCC1-XX-2**  
Double-ended vertical ceiling  
Kits

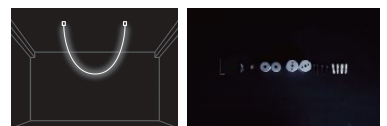

**-AS-NNR18LCX-1000**  
Horizontal ceiling  
Installation components



**5 SYSTEM CONTROL:**

**-402-02-000000-00001**  
Monochrome Remote Control  
R6-1  
Operating voltage: 3VDC(Battery CR2032)  
Operating frequency: 2.4GHz  
Remote control distance: 30m  
Operating temperature: -30°C-55°C  
Size:L107\*W58.5\*H9(mm)



**-402-0-000000-00013**  
Knob panel controller used for dimming to warm  
CP1-GBB  
Input voltage: 12-24VDC  
Input current: 6A\*1CH  
Operating temperature: -30°C-55°C  
Size: L86\*W86\*H33(mm)



**-402-02-000000-00013**  
Monochrome Control Receiver  
CR1-GBA  
Input voltage: 12-48VDC  
Maximum load current: 15A\*1CH, Max15A@12/24V  
10A \*1CH, Max10A@36/48V  
Maximum load power: 15A\*1CH, Max15A@12/24V  
10A \*1CH, Max10A@36/48V  
Operating temperature: -30°C-55°C  
Size: L175\*W45\*H27(mm)



**THINK BOLLARD - THINK BULLARD**

sales@gordonbullard.com  
www.bullardbollards.com  
1-877-964-4646



991 South Gull Lake Dr  
Richland, MI 49083  
USA



FIXTURE TYPE: \_\_\_\_\_

PROJECT NAME: \_\_\_\_\_

**HOW TO ORDER:**

**CODE:**

**Example:**  
CODE: BB-FLX360R18-CL-LS1-ECT-AS-NNR18VTD-  
XX-2-402-02-000000-00001-402-02-000000-00013

BB-FLX360R18-CL-  
LS1-ECT-AS-  
NNR18VTD-  
XX-2-402-02-00000  
0-00001-402-02-00  
0000-00013

**5 SYSTEM CONTROL:**

**-402-02-000000-00002**

CCT Remote Control  
R7-1  
Operating voltage: 3VDC(Battery CR2032)  
Operating frequency: 2.4GHz  
Remote control distance: 30m  
Operating temperature: -30°C-55°C



**-402-01-000000-00002**

CCT Control Receiver  
CR2-GBA  
Input voltage: 12-48VDC  
Maximum load current: 8A\*2CH, Max16A  
Maximum load power: 192W/384W@12V/24V  
1384W/576W@36V/48V  
Operating temperature: -30°C-55°C  
Size: L170\*W50\*H23(mm)



**-402-02-000000-00003**

RGB/RGBW Remote Control  
R8-1  
Operating voltage: 3VDC (Battery CR2032)  
Operating frequency: 2.4GHz  
Remote control distance: 30m  
Operating temperature: -30°C-55°C  
Product Size: L107\*W58.5\*H9(mm)



**-402-01-000000-00003**

RGB Control Receiver  
CR3-GBA  
Input voltage: 12-48VDC  
Maximum load current: 6A\*3CH, Max 18A  
Maximum load power: 216W/432W@12V/24V  
648W/864@36V/48V  
Operating temperature: -30°C-55°C  
Size: L175\*W45\*H27(mm)



**THINK BOLLARD - THINK BULLARD**

sales@gordonbullard.com  
www.bullardbollards.com  
1-877-964-4646



991 South Gull Lake Dr  
Richland, MI 49083  
USA