

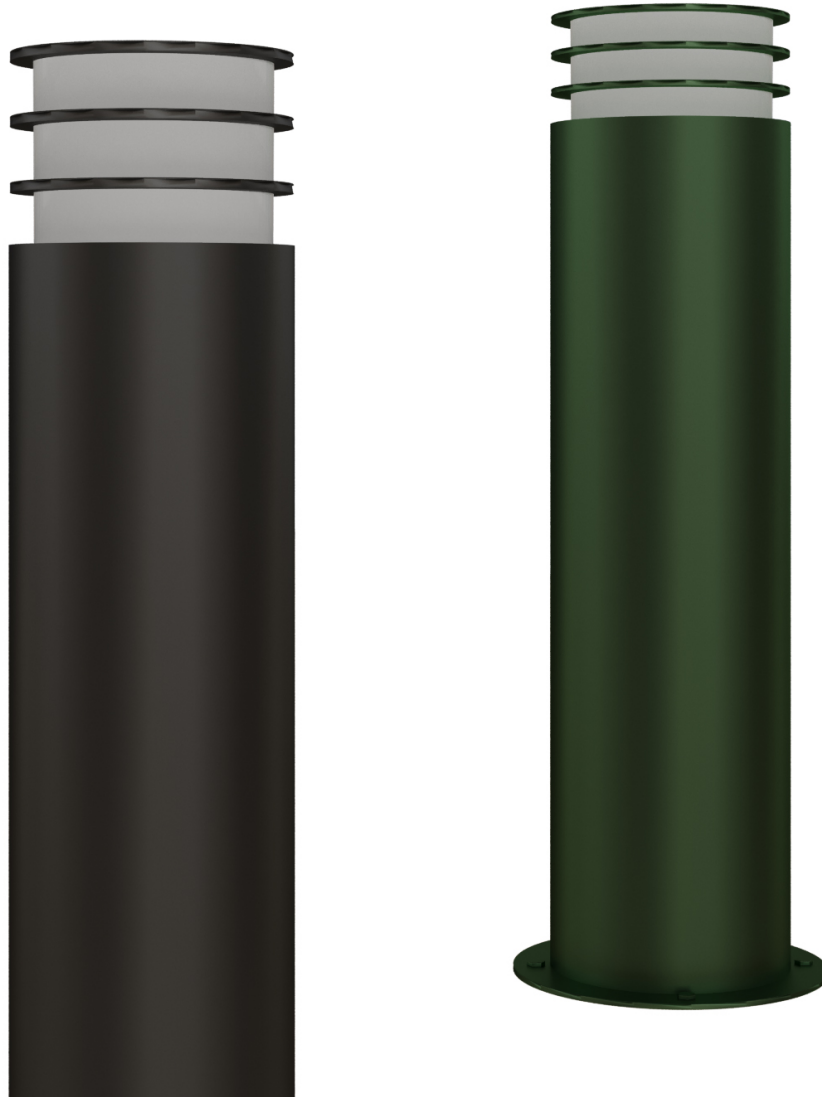

**BULLARD**  
BOLLARDS



# GROOT

(BDS-M30FB36-ST)

---

sales@gordonbullard.com  
www.bullardbollards.com  
1-877-964-4646



---

991 South Gull Lake Dr  
Richland, MI 49083  
USA

1. Mounting of security base in accordance with ASTM CRASH RATED standards

Detailed installation information on page 2 and 3 and 4

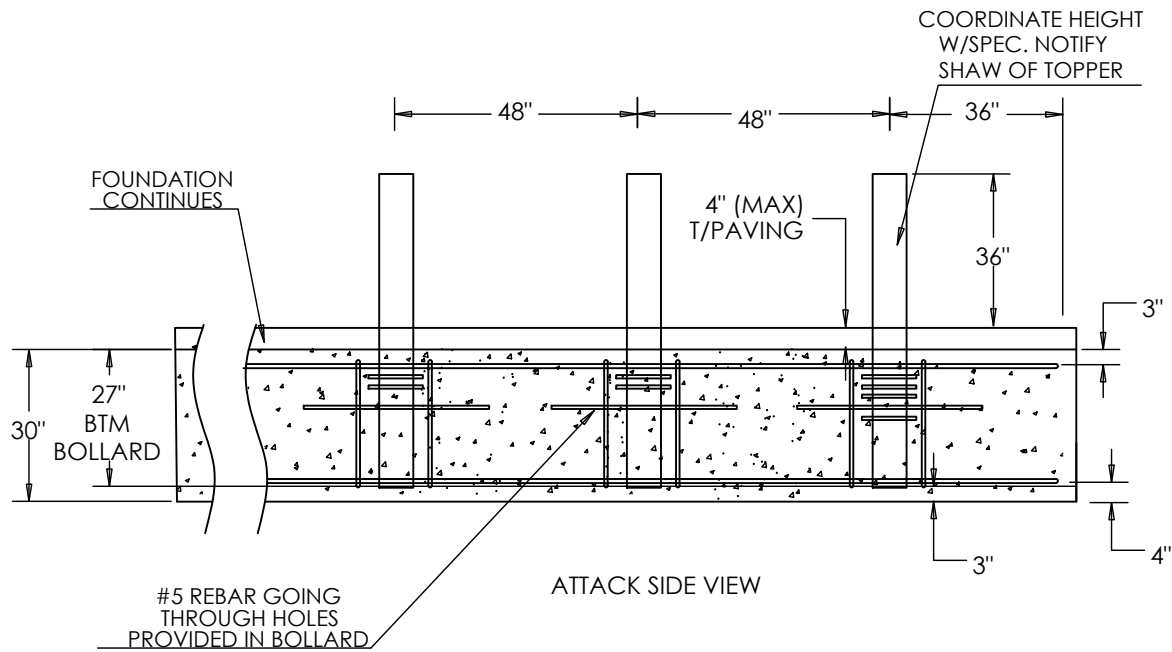

2. Take out the lamps and find the corresponding accessories.

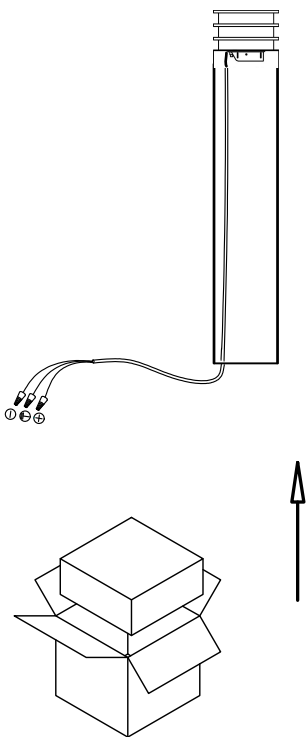

3. Connect the power cord through the three-core waterproof connector  
Please note: the cord should be located between the security pipe and the lit cover, it doesn't need to go into the concrete.  
4. Fix the top lit cover with the set of screws

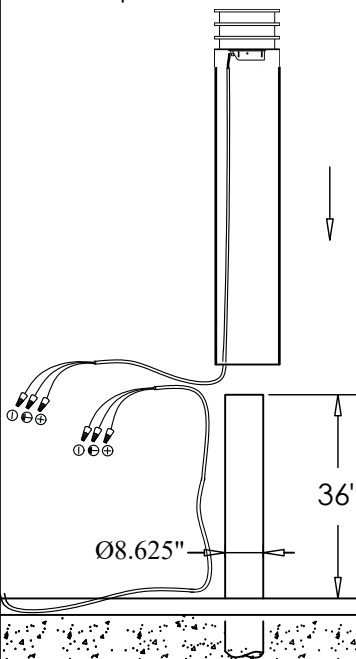

5. Lamp size drawing.

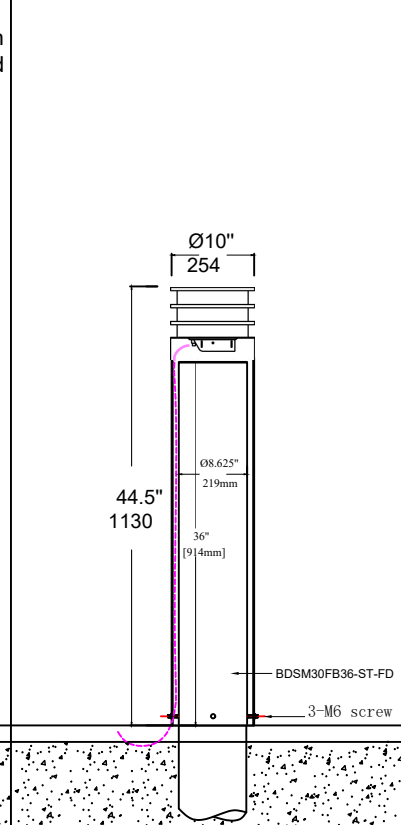

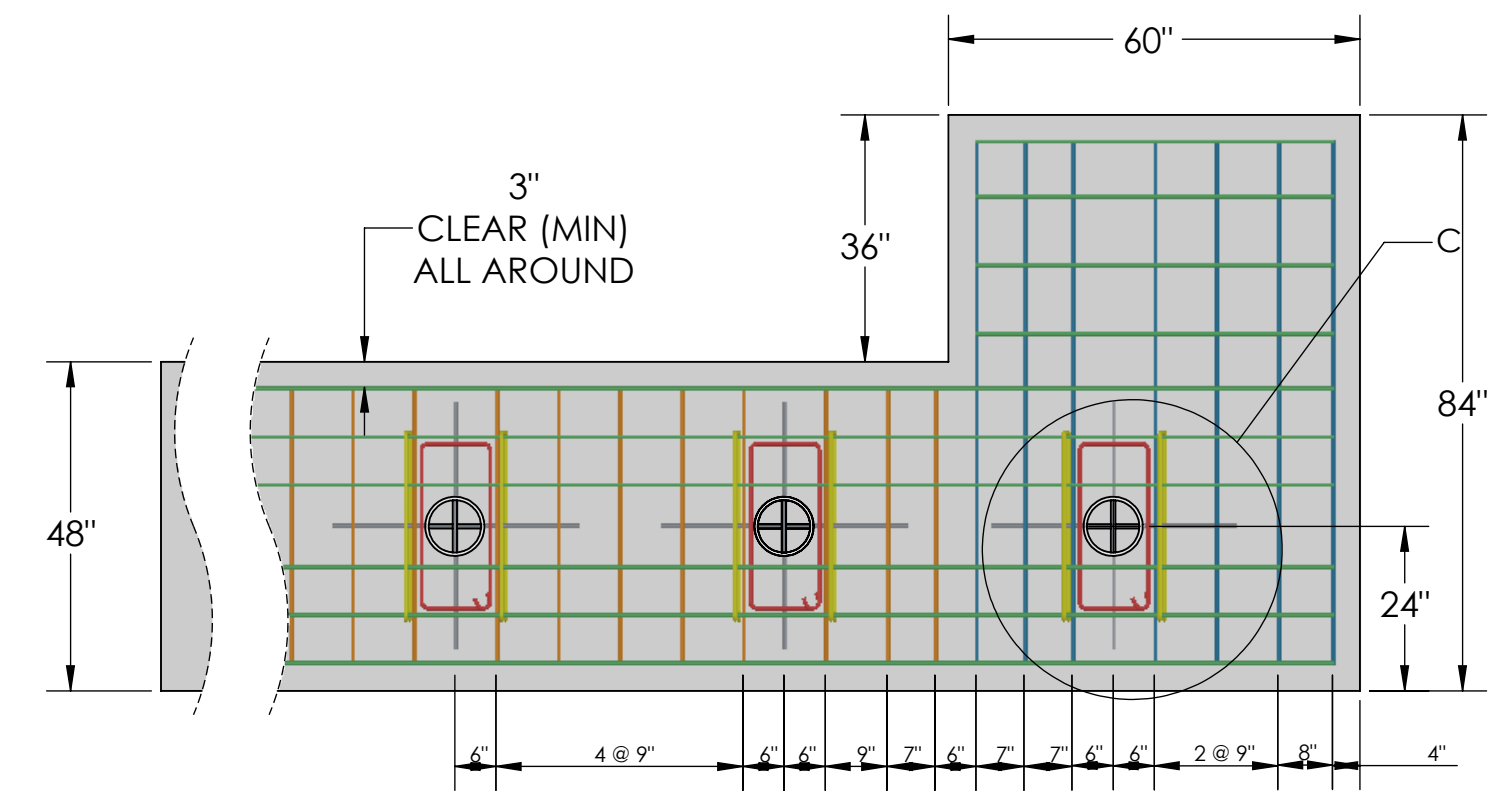
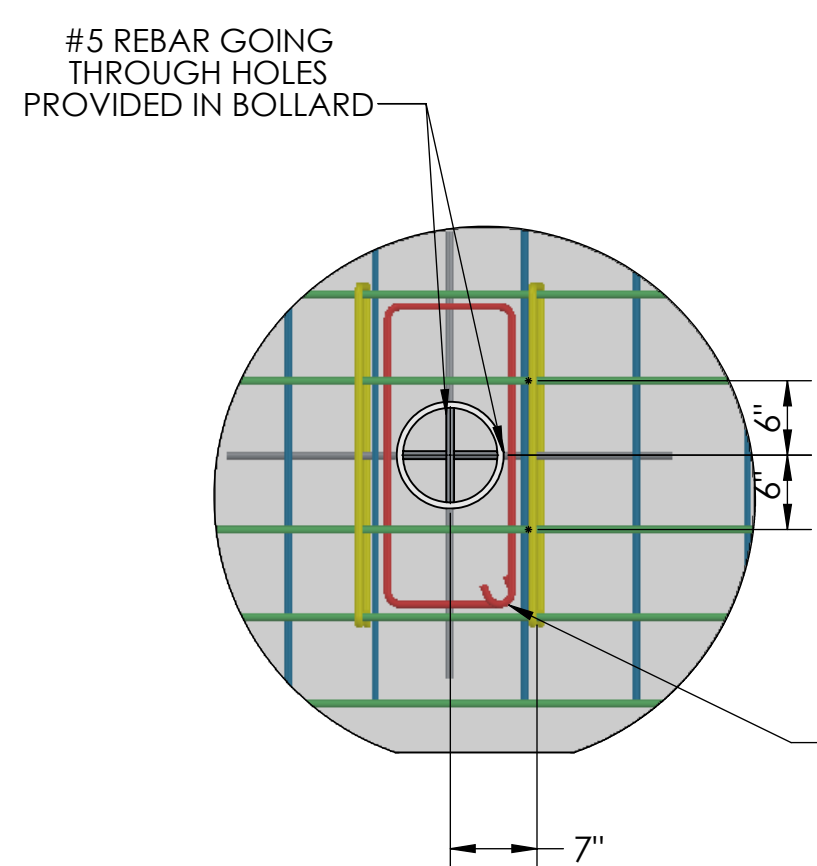
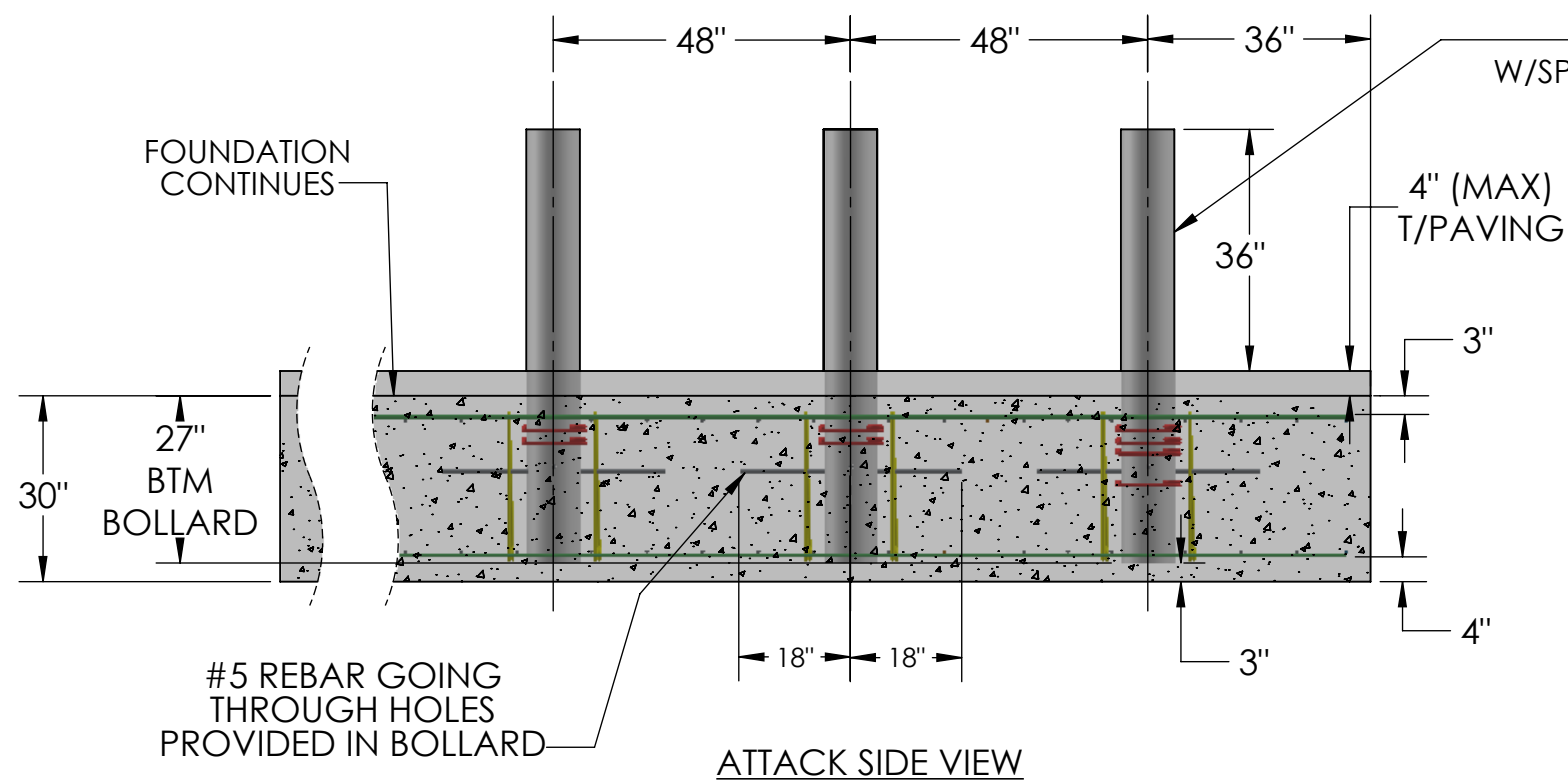

UNLESS OTHERWISE SPECIFIED:		NAME		DATE	
DIMENSIONS ARE IN INCHES		DRAWN BY	S.J.	2/10/2020	
TOLERANCES:		CHECKED BY	J.HU.	2/10/2020	
FRACTIONAL: -0" / +1/16"		ENG APPR.			
ANGULAR: MACH ±1.0° BEND ±2.5°		MFG APPR.			
BREAK ALL SHARP EDGES					
MATERIAL		<b>PROPRIETARY AND CONFIDENTIAL</b> THE INFORMATION CONTAINED IN THIS DRAWING IS THE SOLE PROPERTY OF Gordon Bollard and Co ANY REPRODUCTION IN PART OR AS A WHOLE WITHOUT THE WRITTEN PERMISSION OF Gordon Bollard and Co IS PROHIBITED.			
FINISH					
MILL					
NO MANUAL REVISIONS/CHANGES ALLOWED		REV.		ITEM NO:	
				BDS-M30FB-ST-FD	
		WEIGHT:		SHEET 1 OF 3	



DESCRIPTION:  
M30 FIXED BOLLARD

REV. ITEM NO:  
BDS-M30FB-ST-FD

WEIGHT: SHEET 1 OF 3

ATTACK

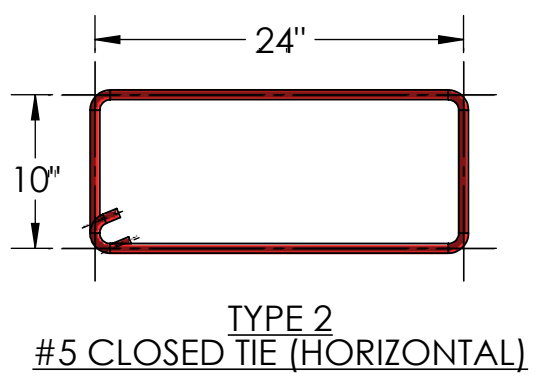
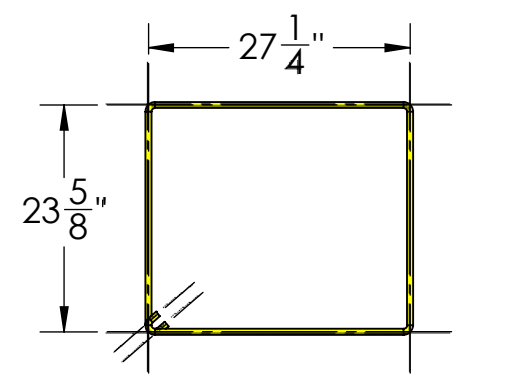
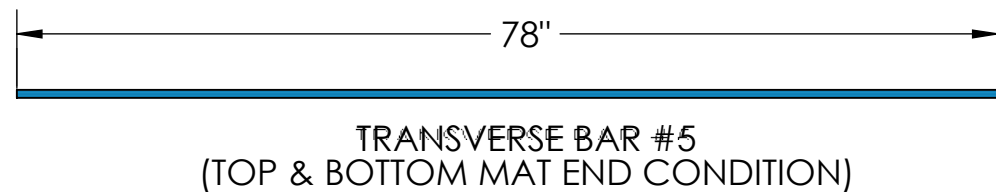
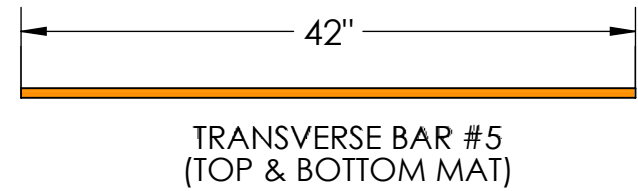
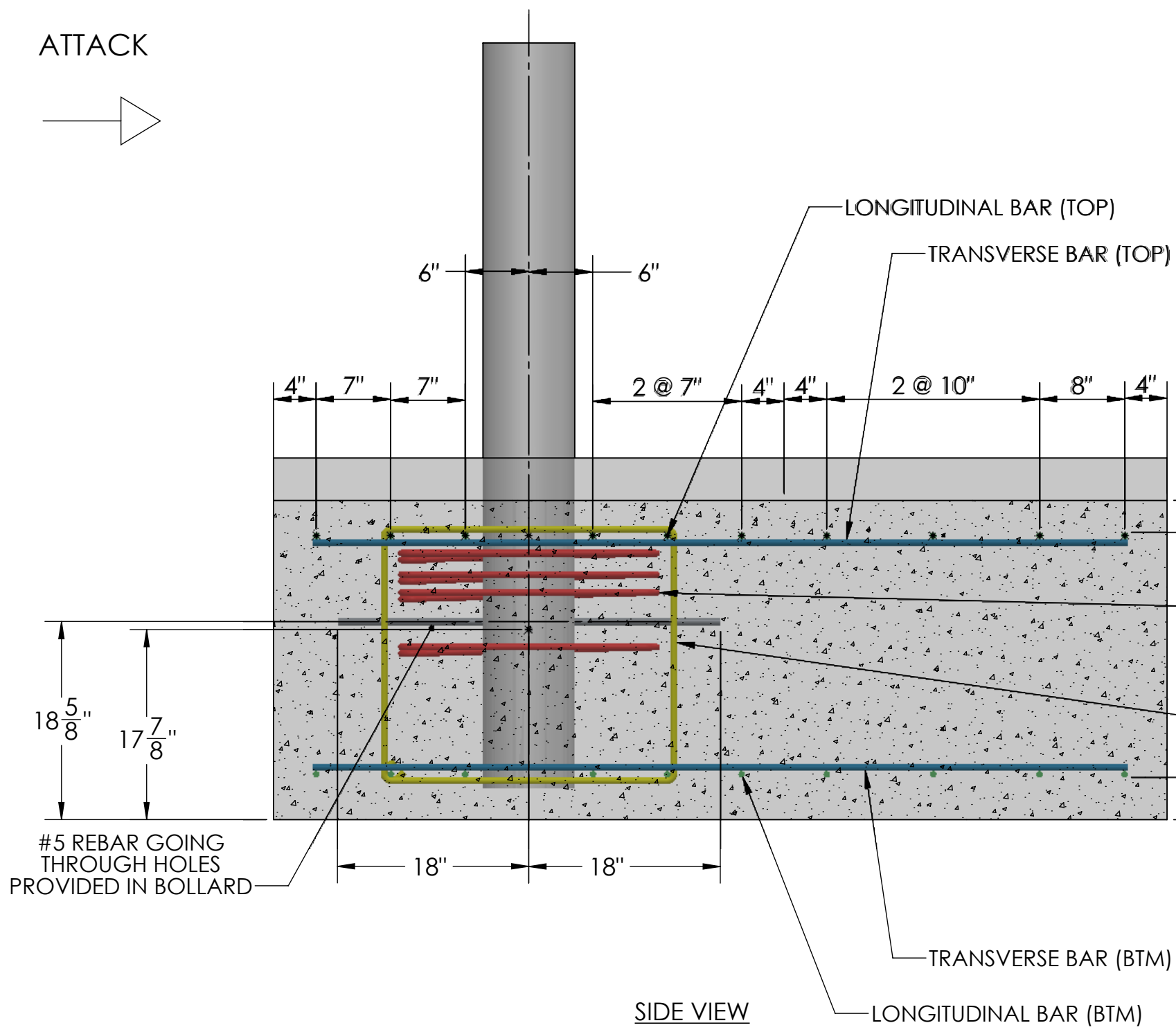
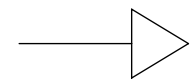

(4) #5 (TYPE 2) CLOSED TIES ON END CONDITION.  
(2) TIES ON OTHER BOLLARDS @ 2" O.C

TYPE 1 TIE

NOTE: LONGITUDINAL BAR - #5 CONTINUOUS

UNLESS OTHERWISE SPECIFIED: DIMENSIONS ARE IN INCHES TOLERANCES: FRACTIONAL: -0" / +1/16" ANGULAR: MACH ±1.0° BEND ±2.5° BREAK ALL SHARP EDGES		DRAWN BY S.J.	NAME S.J.	DATE 2/10/2020	<p>DESCRIPTION: M30 FIXED BOLLARD</p> <p>REV. ITEM NO: BDS-M30FB-ST-FD</p> <p>WEIGHT: SHEET 2 OF 3</p>
MATERIAL		CHECKED BY J.HU.	ENG APPR.	MFG APPR.	
FINISH MILL		<p>PROPRIETARY AND CONFIDENTIAL THE INFORMATION CONTAINED IN THIS DRAWING IS THE SOLE PROPERTY OF Gordon Bollard and Co ANY REPRODUCTION IN PART OR AS A WHOLE WITHOUT THE WRITTEN PERMISSION OF Gordon Bollard and Co IS PROHIBITED.</p>			
NO MANUAL REVISIONS/CHANGES ALLOWED					

1. - GENERAL:

- a. ALL NOTES THIS PAGE ARE APPLICABLE TO THE DRAWINGS AND DETAILS PROVIDED FOR FIXED AND REMOVABLE BOLLARDS ONLY.
- b. THE CONTRACTOR SHALL USE MATERIALS AND EMPLOY CONSTRUCTION METHODS IN ORDER TO COMPLY WITH THE DESIGN DRAWINGS. CONTRACTOR SHALL INFORM THE ENGINEER IN WRITING OF ANY SPECIFIC DEVIATIONS AND OBTAIN ENGINEER'S WRITTEN APPROVAL FROM THE SPECIFIC DEVIATION.
- c. IT IS THE CONTRACTOR'S SOLE RESPONSIBILITY TO FOLLOW ALL APPLICABLE SAFETY CODES AND REGULATIONS DURING ALL PHASES OF CONSTRUCTION
- d. THE CONTRACTOR SHALL VERIFY ALL DIMENSIONS AND EXISTING CONDITIONS.

2. - FOUNDATIONS:

- a. DESIGN "NET" ALLOWABLE SOLID BEARING PRESSURE OF 3000 POUNDS/SQ. FOOT, AT A DEPTH OF 10IN. BELOW ADJACENT GRADE. ALL FOOTING EXCAVATIONS TO BE VERIFIED BY OTHERS. IT IS THE RESPONSIBILITY OF THE CONTRACTOR TO REPORT ADVERSE CONDITIONS.
- b. THE EXCAVATION SHALL BE KEPT DRY AT ALL TIMES. GROUNDWATER SHALL BE REMOVED FROM THE EXCAVATION.
- c. CONTRACTOR SHALL REMOVE ALL LOOSE SOLID OR ROCK FROM THE FOOTING EXCAVATION PRIOR TO CONCRETE PLACEMENT.
- d. SUBGRADE SHALL BE UNIFORMLY COMPACTED TO AT LEAST 95 PERCENT OF THE STANDARD PROCTOR MAXIMUM DRY DENSITY.

3. - CONCRETE:

- a. CONCRETE SHALL CONFORM TO ACI BUILDING CODE 318-14. UNLESS NOTED, CONCRETE SHALL BE NORMAL WEIGHT, 4500 PSI @ 28 DAYS WITH MAX. WATER-CEMENTIOUS MATERIAL RATIO OF 0.45. MAXIMUM SLUMP FOR CONCRETE SHALL BE 5" ± AT POINT OF PLACEMENT.
- b. UNLESS NOTED, CEMENT SHALL CONFORM TO ASTM C150 TYPE II, AGGREGATES SHALL BE NORMAL WEIGHT CONFORMING TO ASTM C33.
- c. CONCRETE SHALL BE AIR-ENTRAINED IN ACCORDANCE WITH ACI 318-14, "TOTAL AIR CONTENT FOR THE CONCRETE EXPOSED TO CYCLES OF FREEZING & THAWING."
- d. HOT WEATHER CONCRETE PLACEMENT SHALL COMPLY WITH ACI 305R. COLD WEATHER CONCRETE PLACEMENT SHALL COMPLY WITH ACI 306R-16.
- e. CONCRETE CURING SHALL COMPLY WITH ACI 308R.
- f. CONCRETE SHALL BE CONSOLIDATED AND SHALL COMPLY WITH ACI 309R.
- g. CONTROL JOINTS SHALL BE SCORED OR SAW-CUT JOINTS (1" DEEP FILLED WITH SEALANT) TO MATCH EXISTING CONDITION AND BE PLACED AT A MAXIMUM SPACING OF 12 FEET ON-CENTER. CONCRETE SURFACES THAT ARE EXPOSED SHALL COMPLY WITH THE BUILDING CODE REQUIREMENTS.

4. - REINFORCING STEEL:

- a. REINFORCING STEEL SHALL CONFORM TO ASTM A-615, GRADE 60. PROVIDE A MINIMUM BAR LAP OF 60 BAR DIAMETERS. STAGGER LAPS WHERE POSSIBLE.
- b. REINFORCING THAT IS WELDED SHALL BE WELDABLE TYPE ASTM A-706.

UNLESS OTHERWISE SPECIFIED:						
DIMENSIONS ARE IN INCHES		NAME	DATE			
TOLERANCES:		DRAWN BY	S.J.			2/10/2020
FRACTIONAL: -0" / +1/16"		CHECKED BY	J.HU.			2/10/2020
ANGULAR: MACH ±1.0° BEND ±2.5°		ENG APPR.			DESCRIPTION: GENERAL INSTALL NOTES	
BREAK ALL SHARP EDGES		MFG APPR.				
MATERIAL		<b>PROPRIETARY AND CONFIDENTIAL</b> <b>THE INFORMATION CONTAINED IN THIS</b> <b>DRAWING IS THE SOLE PROPERTY OF</b> <b>Gordon Bollard and Co</b> <b>ANY REPRODUCTION IN PART OR AS A</b> <b>WHOLE WITHOUT THE WRITTEN PERMISSION</b> <b>OF Gordon Bollard and Co IS PROHIBITED.</b>			REV.	ITEM NO:
FINISH						
MILL						
NO MANUAL REVISIONS/CHANGES ALLOWED				WEIGHT:	SHEET 3 OF 3	