



**BULLARD
BOLLARDS**
Think Bollard Think Bullard

BREAK LINE
(ILLUMINATED FURNITURE)





FIXTURE TYPE: _____

PROJECT NAME: _____

NOTES:



GENERAL INFORMATION:

Break Line is a luminous bar counter, which belongs family display. Break Line is a luminous bar counter, minimal and versatile, which lights up indoors and outdoors, small areas and huge gardens. Break Line could have a top in tempered glass. Resistant and easy to clean, Break Line is an ideal solution for contract and events. It is possible to complete Break Line with some accessories, as a speed rack and a cocktail station. The luminous bar counter Break Line is made in polyethylene with the technology of rotational moulding. It is available only in lighting white and it is possible to customize it with logos or images.

FIXTURE TYPE:

Illuminated Furniture

VOLTAGE:

110-277V

MATERIAL:

Polyethylene

IP RATING:

IP 55

IP 55

FINISH OPTION:

Light white

WARRANTY:

Lighting products are warranted for 5 years.

APPLIANCE CLASS:

II



THINK BOLLARD - THINK BULLARD

sales@gordonbullard.com

www.bullardbollards.com

1-877-964-4646



991 South Gull Lake Dr

Richland, MI 49083

USA



FIXTURE TYPE: _____

PROJECT NAME: _____

NOTES:

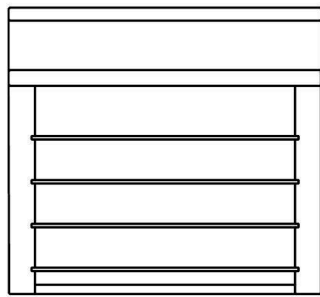

47.24"
[120 cm]
A)

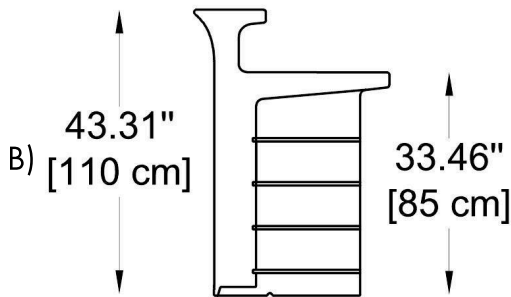

43.31"
[110 cm] B)

33.46"
[85 cm]

29.53"
[75 cm] C)

E26

IP 55



HOW TO ORDER:

CODE:

**Example:
CODE: BB-LPBRD-SD**

BB-LPBRD-SD

1 DIMENSIONS:

A) Length - L: 47,24" (120 cm)
B) Height - H: 43,31" (110 cm)
C) Width - W: 29,53" (75 cm)

2 LIGHT SOURCE:

E26 / 2 x max. 10W / 110-277V

3 FINISH OPTION:

Light white

4 WIRING:

Black cable (Length 10 ft.)

5 WEIGHT:

88, 18 lb

6.1 ACCESSORIES: (not-included)

DESKS:

-116 Satinated glass
-114 Steel silver

Satinated glass Steel silver

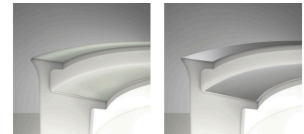

6.2 ACCESSORIES: (not-included)

TOPS:

-117 Satinated glass
-115 Steel silver

Satinated glass Steel silver

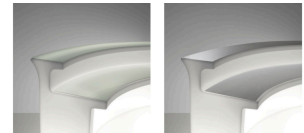

THINK BOLLARD - THINK BULLARD

sales@gordonbullard.com

www.bullardbollards.com

1-877-964-4646



991 South Gull Lake Dr

Richland, MI 49083

USA



FIXTURE TYPE: _____

PROJECT NAME: _____

NOTES:

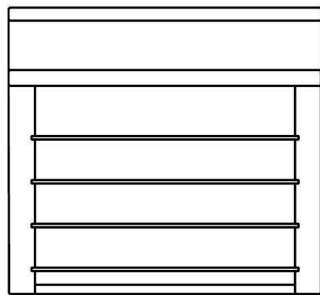

47.24"
[120 cm]
A)

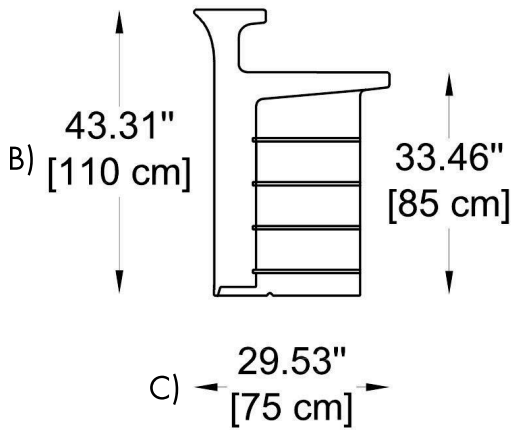

43.31"
B) [110 cm]

33.46"
[85 cm]

29.53"
C) [75 cm]

HOW TO ORDER:

CODE:

**Example:
CODE: BB-LPBRD-SD**

BB-LPBRD-SD

6.3 ACCESSORIES: (not-included)

SHELF:

-111 Tempered glass (max. 4 shelves per counter)

6.4 ACCESSORIES: (not-included)

CODE: -112

COCKTAIL STATION

Material - ABS

Dimensions:

L: 21.46" (54,5 cm)

H: 14.57" (37 cm)

W: 33.07" (84 cm)

Finish options - Black

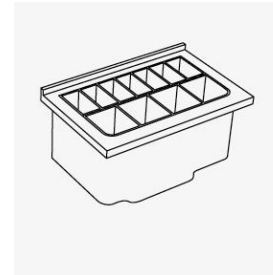

6.5 ACCESSORIES: (not-included)

CODE: -113

SPEED RACK

Material - ABS

Dimensions:

L: 3.94" (10 cm)

H: 8.07" (20,5 cm)

W: 33.07" (84 cm)

Finish options - Black

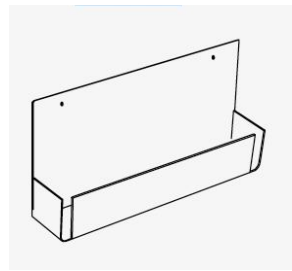

E26

IP 55



THINK BOLLARD - THINK BULLARD

sales@gordonbullard.com

www.bullardbollards.com

1-877-964-4646



991 South Gull Lake Dr

Richland, MI 49083

USA