

# ARGUS



**Data Sheet:**

Input Voltage (V): 110-277  
IK 06

Installation steps

Step 1

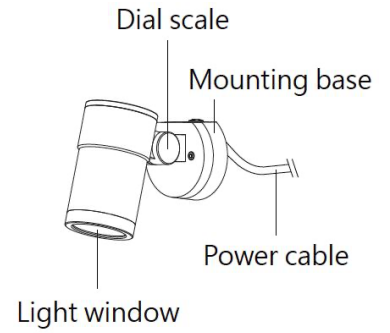
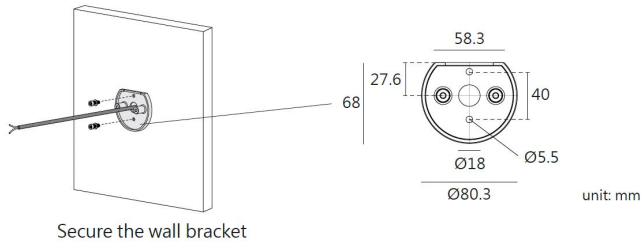

Bevel cut hood & Honeycomb louver

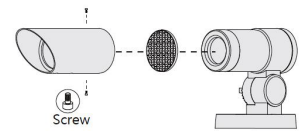

Step 2

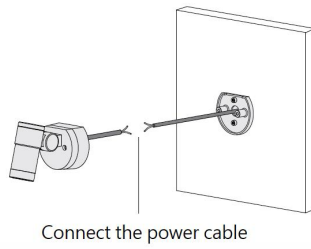

Step 3

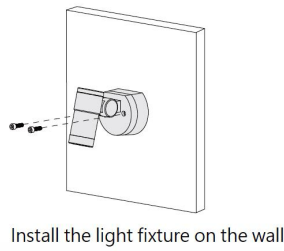

**4.2 Tree pole strap**

Step 1

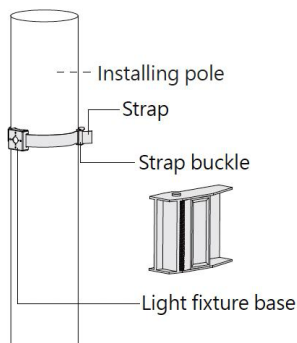

Step 2

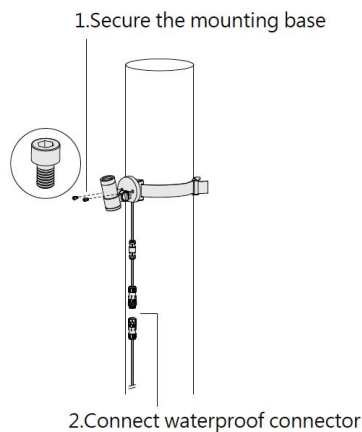

Step 3

