



**BULLARD
BOLLARDS**
Think Bollard Think Bullard



GROOT

PU40
RATING

ILLUMINATED **SECURITY & SAFETY BOLLARDS**



Fixture Type:

Project Name:

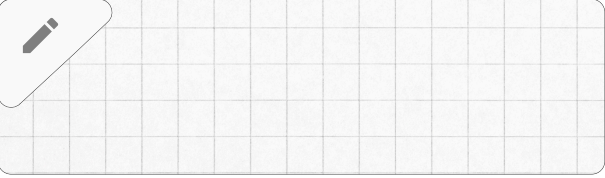

General Information:

A contemporary approach to safety and structure, GROOT SKY combines robust protection with refined illumination to support safer, more legible environments. Its durable construction and LED technology enhance visibility while reinforcing clear boundaries between vehicles and pedestrians.

With customizable heights, finishes, and light temperatures, it adapts easily to varied architectural contexts without compromising performance.

Applications: pedestrian areas, mixed-use developments, access points

Fixture Type:

Illuminated Security & Safety Bollard

Lighting:

LED

Voltage:

110-277V

Material:

Stainless Steel

Driver Position:

Integral

IP Rating:

IP 65

Appliance Class:

I

Lighting Distribution:

360°

Warranty:

LED lighting products are warranted for 5 years.

Main Features:

- High visual comfort
- Available in a wide range of finishes
- Functional and minimalistic design
- Shock-resistant construction
- Operating Temperature: -104°F to +140°F.



Due to the dynamic nature of lighting products and the associated technologies, luminaire data on all specification sheets is subject to change at the discretion of Gordon Bullard LLC and associated companies.





THINK BOLLARD - THINK BULLARD

sales@gordonbullard.com / www.bullardbollards.com / 1-877-964-4646
991 South Gull Lake Dr Richland, MI 49083 USA

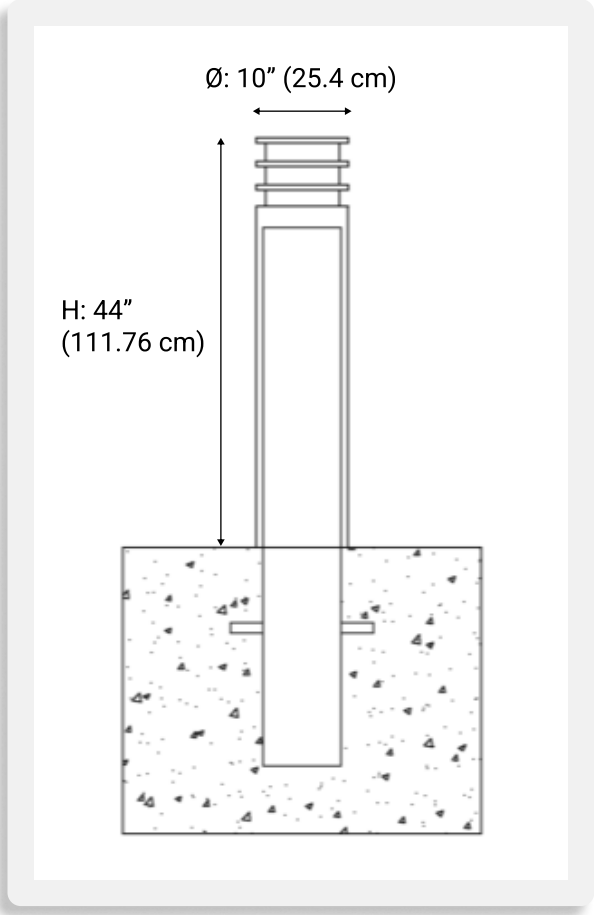
Fixture Type:

Project Name:



LED		IP65		
PU40 RATING				

HOW TO ORDER:

CODE:

CODE EXAMPLE:
BB-GRT-GLC-PU40-LSB10-FC-K35-NON-BL

**BB-GRT-GLC-
PU40-LSB10-FC-
K35-NON-BL**

1 DIMENSIONS:

Diameter - Ø: 10" (25.4 cm)
Overall Height - H: 44" (111.76 cm)

2 LIGHT SOURCE OUTPUT BOLLARD:

- LSB6 6 W / 396 lm
- LSB9 9 W / 580 lm
- LSB10 10 W / 590 lm
- LSB15 15 W / 880 lm
- LSB20 20 W / 1280 lm
- LSBC Custom Lumen packages on request*

3 LENS:

- SC Standard Clear
- FC Frosted Acrylic

4 CCT:

- K22 2200K
- K30 3000K
- K35 3500K
- K40 4000K
- K50 5000K

5 DIMMING OPTIONS:

- NON NON-Dimmable
- DIM 0-10V

6 FINISH OPTIONS:

- WH White (RAL 9010)
- BL Black (RAL 9005)
- BR Bronze (RAL 8004)
- LG Light Grey (RAL 7047)
- DK Dark Grey (RAL 7021)
- BSS Brushed Stainless Steel
- CUS Custom on request*



Due to the dynamic nature of lighting products and the associated technologies, luminaire data on all specification sheets is subject to change at the discretion of Gordon Bullard LLC and associated companies.

THINK BOLLARD - THINK BULLARD

sales@gordonbullard.com / www.bullardbollards.com / 1-877-964-4646
991 South Gull Lake Dr Richland, MI 49083 USA

ASTM CRASH RATINGS EXPLAINED

ASTM crash ratings (ASTM F2656) are a U.S. standard used to classify the performance of vehicle security barriers based on their ability to stop a 15,000 lb (6,800 kg) truck at defined impact speeds. The rating combines impact speed—M30 (30 mph), M40 (40 mph), or M50 (50 mph)—with a penetration level (P1, P2, P3), indicating how far the vehicle travels past the barrier after impact, providing a clear benchmark for selecting appropriate protection against specific vehicle-borne threats.

THE RATING CATEGORIES BREAK DOWN AS FOLLOWS:

SC  (SC) Small Passenger Car

- Vehicle weight: 2,430 lbs
- Speed ratings: SC40 (40 mph), SC50 (50 mph), SC60 (60 mph)
- Use case: Low-mass vehicle threats; urban or light-security environments

PU  (PU) Pickup Truck

- Vehicle weight: 5,070 lbs
- Speed ratings: PU40 (40 mph), PU50 (50 mph), PU60 (60 mph)
- Use case: Mid-range threats; commercial zones, parking perimeters

M  (M) Medium-Duty Truck

- Vehicle weight: 15,000 lbs
- Speed ratings: M30 (30 mph), M40 (40 mph), M50 (50 mph)
- Use case: Elevated risk scenarios; logistics hubs, public infrastructure



Due to the dynamic nature of lighting products and the associated technologies, luminaire data on all specification sheets is subject to change at the discretion of Gordon Bullard LLC and associated companies.

THINK BOLLARD - THINK BULLARD

sales@gordonbullard.com / www.bullardbollards.com / 1-877-964-4646

991 South Gull Lake Dr Richland, MI 49083 USA

FOUNDATION OPTIONS EXPLAINED

Understanding foundation type and depth is critical to ensure the bollard performs as designed under impact. Improper installation can significantly reduce crash-rating effectiveness and compromise site safety.



Deep Foundation

- **Excavation:** 47.25 in (1200 mm) depth
- **Reinforcement:** Rebar cage (#5 / #8)
- **Installation:** Bollard embedded and fully encased in concrete
- **Function:** Transfers impact load into deep concrete mass



Due to the dynamic nature of lighting products and the associated technologies, luminaire data on all specification sheets is subject to change at the discretion of Gordon Bullard LLC and associated companies.

THINK BOLLARD - THINK BULLARD

sales@gordonbullard.com / www.bullardbollards.com / 1-877-964-4646

991 South Gull Lake Dr Richland, MI 49083 USA