

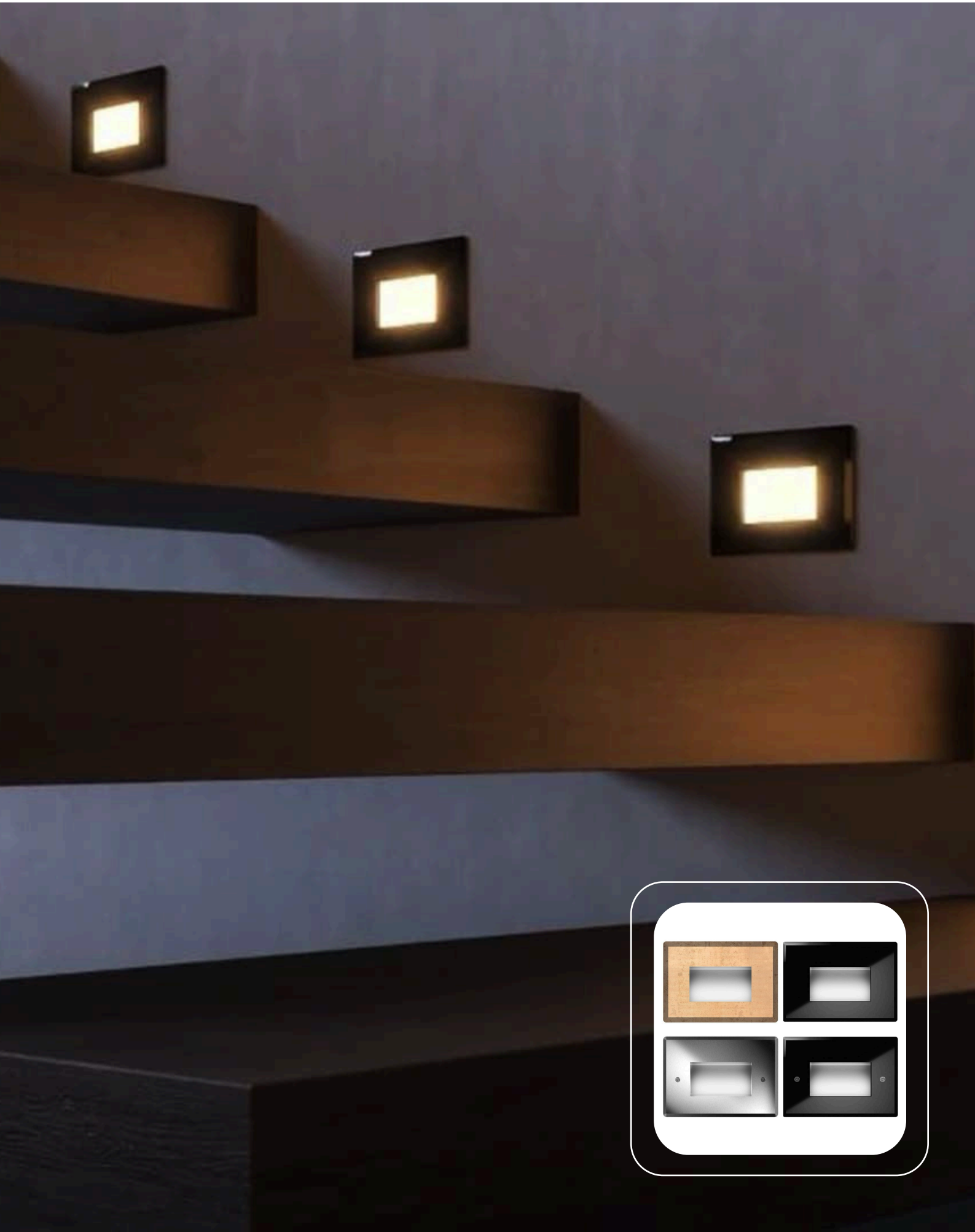

**BULLARD  
BOLLARDS**  
Think Bollard Think Bullard

# BUNNY PASS



FIXTURE TYPE: \_\_\_\_\_

PROJECT NAME: \_\_\_\_\_

NOTES:

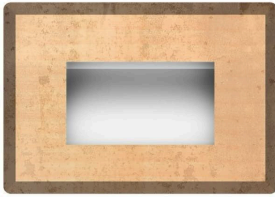
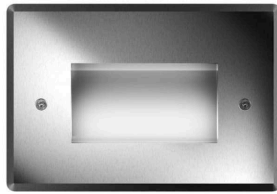
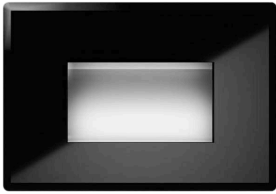

**GENERAL INFORMATION:**

BUNNY PASS it is a series of recessed wall luminaires with reduced recessed depth. They are designed for lighting of paths, stairs and passages with diffused light. The construction of the body, in aluminum alloy with high resistance to oxidation, treated with nano-bonderite and protected with polyester powder-coating, make the product resistant to atmospheric agents and UV rays, guaranteeing maximum protection over the years. The silicone gaskets ensure maximum sealing in all operating and temperature conditions. The diffuser in tempered sodium calcium glass finished with silk-screen printing and beveled edge gives a touch of class to the fixture. The product is installed with a standard polystyrene rough-in housing and is suitable for both concrete and conventional walls. The drywall version is easy to install with harmonic steel springs.

**LIGHTING:**

LED 

**VOLTAGE:**

110-277V 

**GASKETS:**

Silicone gaskets

**FIXTURE TYPE:**

Wall Recessed

**MATERIAL:**

Die-cast aluminum EN AB 44100 highly resistant to oxidation

**BEAM ANGLE:**

97° x 96° x 40°

**DIFFUSER MATERIAL:**

Tempered glass 5mm

**IP RATING:**

IP 65 

**APPLINCE CLASS:**

I 

**THINK BOLLARD - THINK BULLARD**

sales@gordonbullard.com  
 www.bullardbollards.com  
 1-877-964-4646



991 South Gull Lake Dr  
 Richland, MI 49083  
 USA

FIXTURE TYPE: \_\_\_\_\_

PROJECT NAME: \_\_\_\_\_

NOTES:

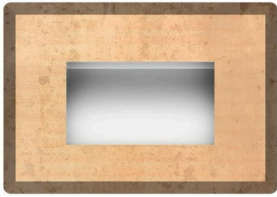
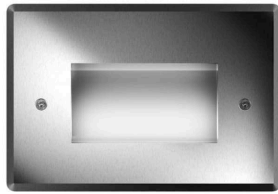
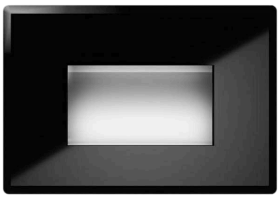

**DRIVER POSITION:**

Integral

**CRI:**

>90

**CABLE TYPE:**

H05RN-F 3x1mm<sup>2</sup>

**CORD LENGTH:**

0.2m

**BEAM DIRECTIONABILITY:**

Fixed optics

**WARRANTY:**

LED lighting products are warranted for 5 years.

**MAIN FEATURES:**

- High visual comfort
- Wide range of finishes
- Functional design
- Minimal design
- Operating Temperature: -22°F~122°F

**THINK BOLLARD - THINK BULLARD**

sales@gordonbullard.com  
www.bullardbollards.com  
1-877-964-4646



991 South Gull Lake Dr  
Richland, MI 49083  
USA



FIXTURE TYPE: \_\_\_\_\_

PROJECT NAME: \_\_\_\_\_

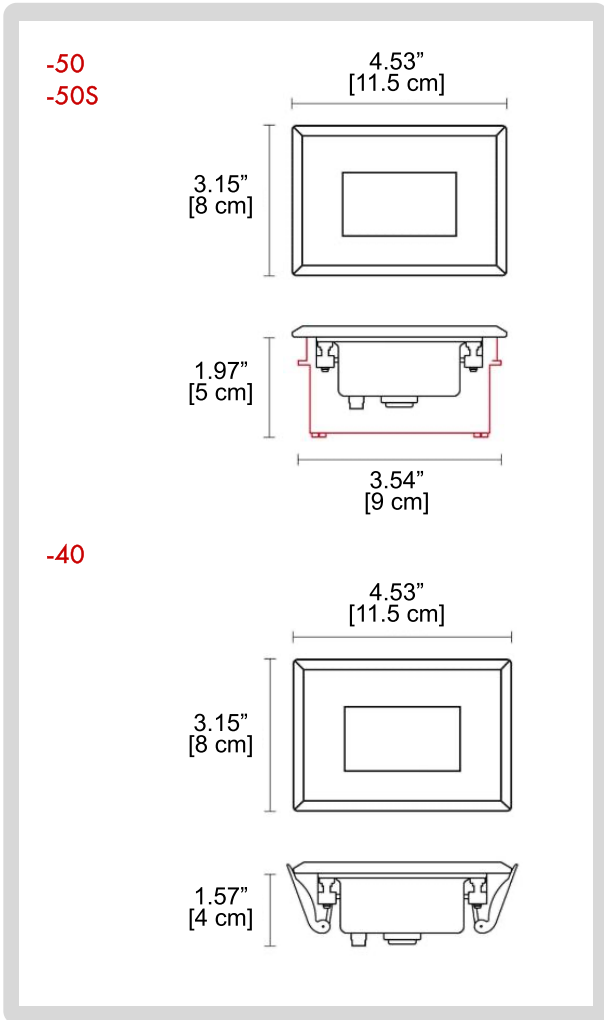

**HOW TO ORDER:**

**CODE:**

**Example:**  
**CODE: BB-001600.BAAT-GH-40-L1-V1-NON-WG**

BB-001600.BA  
AT-GH-40-L1-  
V1-NON-WG

**1 MODELS:**

**-40** (with springs)

A) Length - L: 4.53" [11.5 cm]  
B) Width - W: 3.15" [8 cm]  
C) Height - H: 1.57" [4 cm]

**-50**

A) Length - L: 4.53" [11.5 cm]  
B) Width - W: 3.15" [8 cm]  
C) Height - H: 1.97" [5 cm]

**-50S** (with screws)

A) Length - L: 4.53" [11.5 cm]  
B) Width - W: 3.15" [8 cm]  
C) Height - H: 1.97" [5 cm]

**2 LIGHT SOURCE:**

**-L1** LED | 1 x 2W | 3000K | 1 x 272 lm  
**-L2** LED | 1 x 2W | 4000K | 1 x 288 lm  
**-L3** LED | 1 x 2W | BLUE | 1 x 102 lm

**3 OPERATIONAL VOLTAGE:**

**-V1** 110-277V  
**-V2** 24VDC

**4 DIMMING OPTIONS:**

**-NON** NON-Dimmable  
**-DIM** 0-10V  
**-DAL** Dali

**5 FINISH OPTIONS:**

**-WG** White Glass   
**-BG** Black Glass   
**-SS** Stainless Steel   
**-NB** Natural Bronze 

**THINK BOLLARD - THINK BULLARD**

sales@gordonbullard.com  
www.bullardbollards.com  
1-877-964-4646



991 South Gull Lake Dr  
Richland, MI 49083  
USA

FIXTURE TYPE: \_\_\_\_\_

PROJECT NAME: \_\_\_\_\_

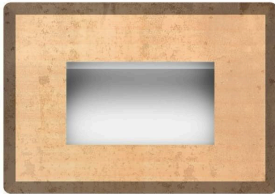
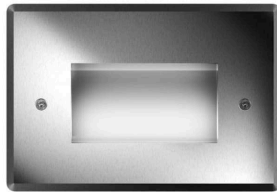
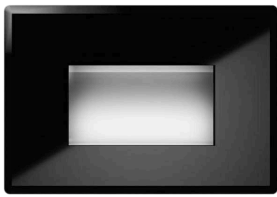

**HOW TO ORDER:**

**CODE:**

**Example:  
CODE: BB-001600.BAAT-GH-40-L1-V1-NON-WG**

**BB-001600.BA  
AT-GH-40-L1-  
V1-NON-WG**

**6 ACCESSORIES:**

**-AC503**

Rough-in housing  
\* Available for 50 and 50S models

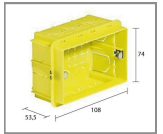

**-AC500**

Well Pass Inox Screw  
\* Available for 50 and 50S models



**-AC141**

Pair of Vandal-Proof screws  
\* Available for 50S model



**-AC142**

Vandal-Proof screw key  
\* Available for 50S model



**THINK BOLLARD - THINK BULLARD**

sales@gordonbullard.com  
www.bullardbollards.com  
1-877-964-4646



991 South Gull Lake Dr  
Richland, MI 49083  
USA