



**BULLARD
BOLLARDS**
Think Bollard Think Bullard

BUNNY TRACK 300 (INGROUND LUMINAIRES)





FIXTURE TYPE: _____

PROJECT NAME: _____

NOTES:

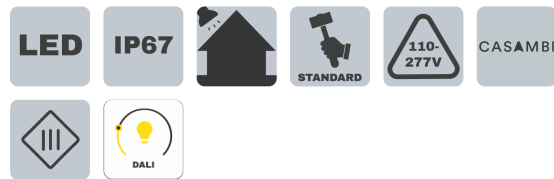

GENERAL INFORMATION:

The Bunny Track 300 is a compact linear inground LED luminaire designed for precise architectural accent and façade lighting. Built with a stainless steel AISI 316L trim and a robust extruded aluminum EN AW-6060 T5 housing, it offers excellent corrosion resistance and durability for demanding outdoor environments, supported by an IP67 rating and an 8 mm tempered glass diffuser. With multiple beam angle options—including narrow, medium, symmetric, and asymmetric wall-washer distributions—it provides flexible lighting effects for pathways, walls, and landscape features. Equipped with high-efficiency LED options in 3000K or 4000K, an included driver, and dimming capabilities such as 0–10V, Casambi, and DALI, the Bunny Track 300 delivers high visual comfort, minimalist design, and reliable long-term performance, backed by a 5-year warranty.

LIGHTING:

LED

VOLTAGE:

110-277V

GASKETS:

Silicone gaskets

FIXTURE TYPE:

Inground Luminaires

MATERIAL:

Stainless steel AISI 316L, Extruded aluminum EN AW-6060 T5 high resistance to oxidation, Die-cast aluminum EN AB 44100 highly resistant to oxidation

EXTERNAL SCREWS:

Stainless steel A4-70 treated with highly antioxidant water-repellent lubricating solution

DIFFUSER MATERIAL:

Tempered glass 8mm

IP RATING:

IP 67

THINK BOLLARD - THINK BULLARD

sales@gordonbullard.com
www.bullardbollards.com
1-877-964-4646



991 South Gull Lake Dr
Richland, MI 49083
USA

FIXTURE TYPE: _____

PROJECT NAME: _____

NOTES:



APPLINCE CLASS:

|||

OPERATION RANGE:

110-277V - 50/60 Hz

DRIVER POSITION:

Included

CRI:

>90

CABLE ENTRY / CABLE TYPE:

Nylon cable gland M20 Ø 7/13 mm / H07RN8-F 3x1 mm²

CORD LENGTH:

0.5m

LIGHT DISTRIBUTION:

- 12° - Symmetrical narrow beam (<=15°)
- 25° - Symmetrical medium flood (15° - 45°)
- 50° - Symmetrical wide beam (45° - 125°)
- 14° x 47° - 2 Axis symmetrical
- 78° x 47° - Asymmetric flood (wall washer)

BEAM DIRECTIONABILITY:

Fixed optics

OPTICS:

Anti UV technopolymer lens

WARRANTY:

LED lighting products are warranted for 5 years.

MAIN FEATURES:

- High visual comfort / Wide range of finishes
- Functional design / Minimal design
- Shock resistant / Operating Temperature: -22°F~122°F

FINISH OPTIONS:

Stainless steel

THINK BOLLARD - THINK BULLARD

sales@gordonbullard.com
 www.bullardbollards.com
 1-877-964-4646



991 South Gull Lake Dr
 Richland, MI 49083
 USA



FIXTURE TYPE: _____

PROJECT NAME: _____

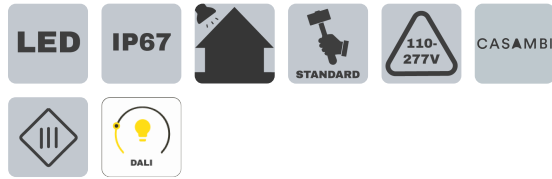
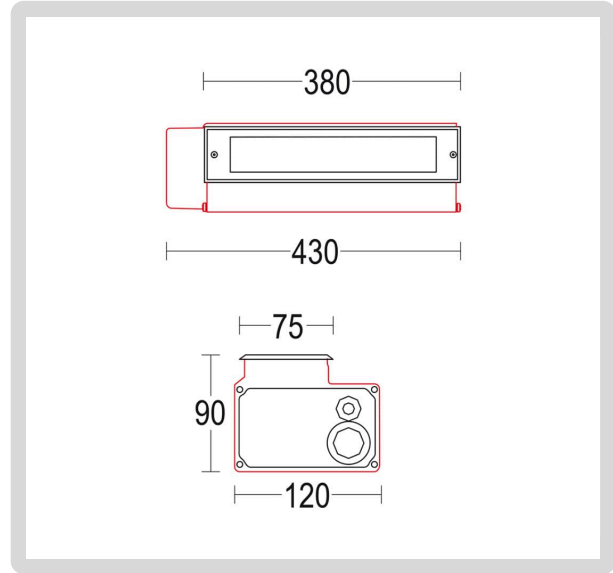

HOW TO ORDER:

CODE:

Example:
CODE: BB-001295.BRST-GH-B2-L2-DIM-AC280

BB-001295.BRST-GH-B2-L2-DIM-AC280

1 MODELS:

- A) Recessed depth - P: 3.54" (9 cm)
- B) Length - L: 14.96" (38 cm)
- C) Width - W: 2.95" (7.5 cm)
- D) Cutout length - CL: 16.93" (43 cm)
- E) Cutout width - CW: 2.80" (7.1 cm)

2 BEAM ANGLE:

- B1 12°
- B2 25°
- B3 50°
- B4 14° x 47°
- B5 78° x 47°





3 LIGHT SOURCE:

- L1 LED | 1 x 9W | 3000K | 1 x 876 lm | 110-277V
- L2 LED | 1 x 9W | 4000K | 1 x 972 lm | 110-277V

4 DIMMING OPTIONS:

- NON NON-Dimmable
- DIM 0-10V
- CAS Casambi
- DAL Dali

5 ACCESSORIES:

- AC204 IP 68 fast connector 4P  **-AC204-5P** IP 68 fast connector 5P 
- AC279 IP 68 connector for through wiring 4P  **-AC279-5P** IP 68 connector for through wiring 5P 
- AC280 Rough-in housing 375x140x100 

THINK BOLLARD - THINK BULLARD

sales@gordonbullard.com
www.bullardbollards.com
1-877-964-4646



991 South Gull Lake Dr
Richland, MI 49083
USA