



**BULLARD  
BOLLARDS**  
Think Bollard Think Bullard



# ILLUMINATED FURNITURE

INSTALLATION TYPE:  
SURFACE-MOUNT



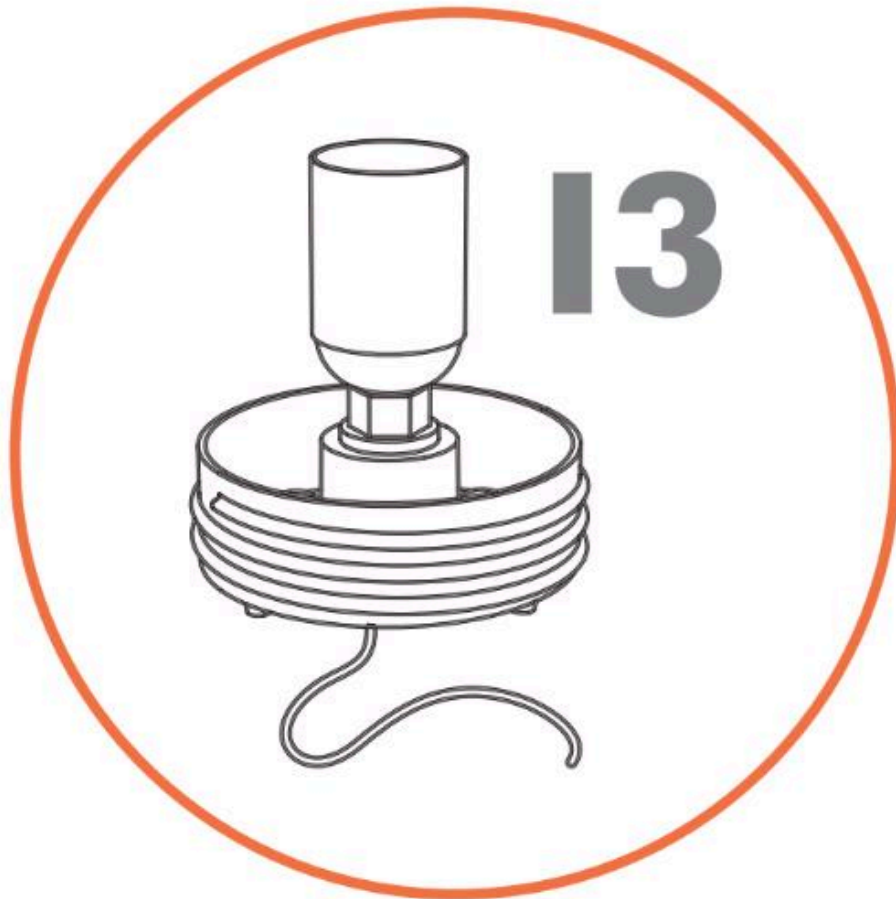

**13**  
BASE MODEL

**BULB REPLACEMENT**

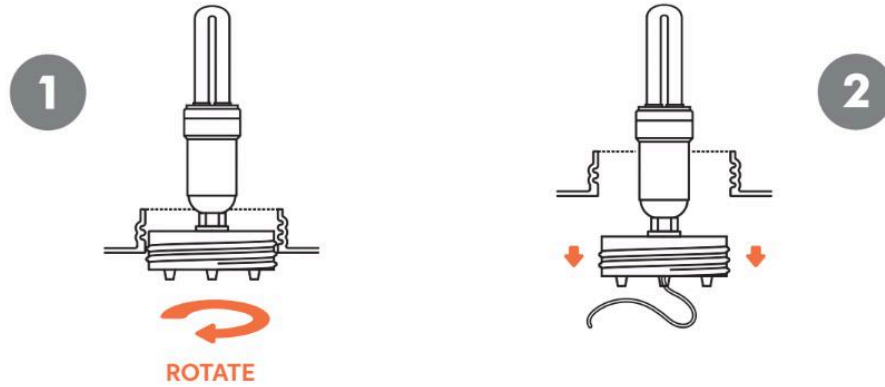

**SYSTEM FOR FLOOR/WALL MOUNTING**

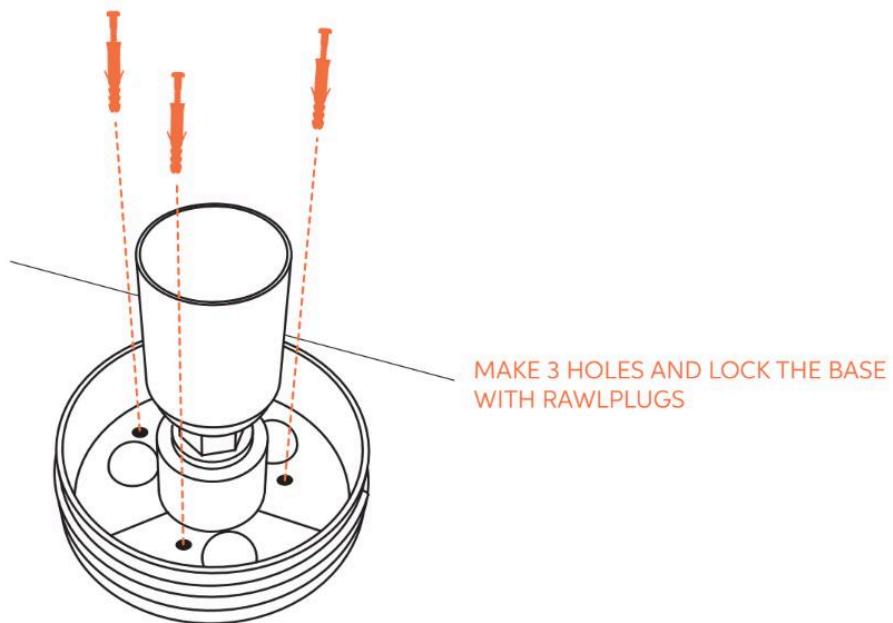

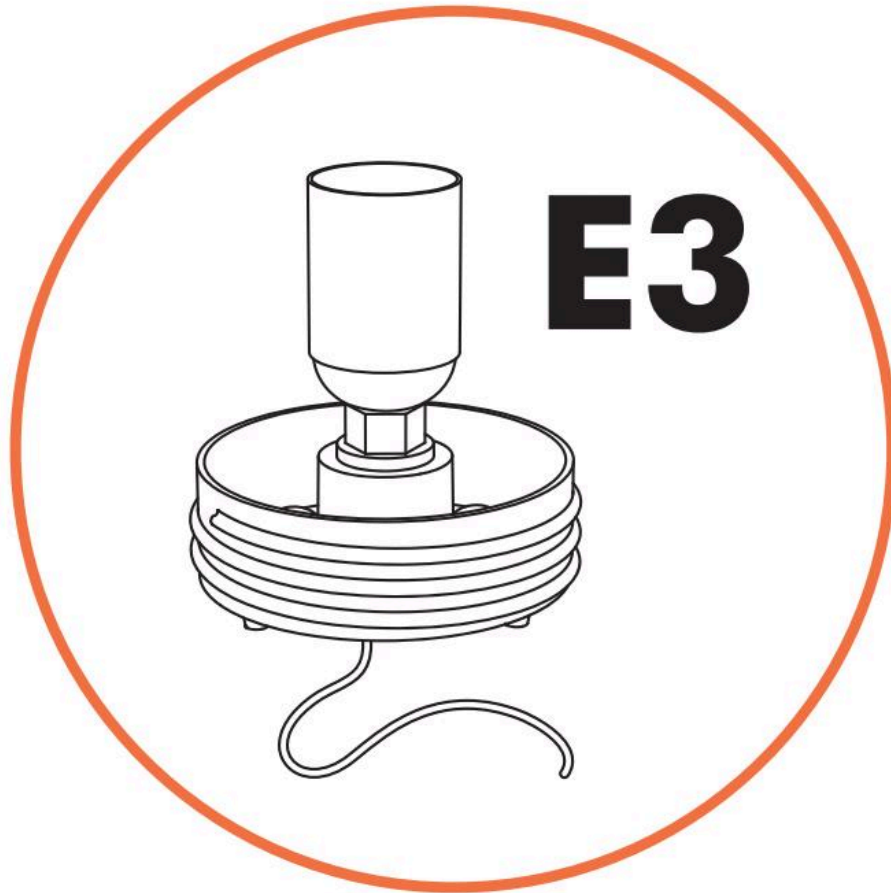

**E3**

**E3**  
BASE MODEL

P.2

[sales@gordonbullard.com](mailto:sales@gordonbullard.com)  
[www.bullardbollards.com](http://www.bullardbollards.com)  
1 877-964-4646



991 South Gull Lake Dr.  
Richland, MI 49083  
USA

**BULB REPLACEMENT**

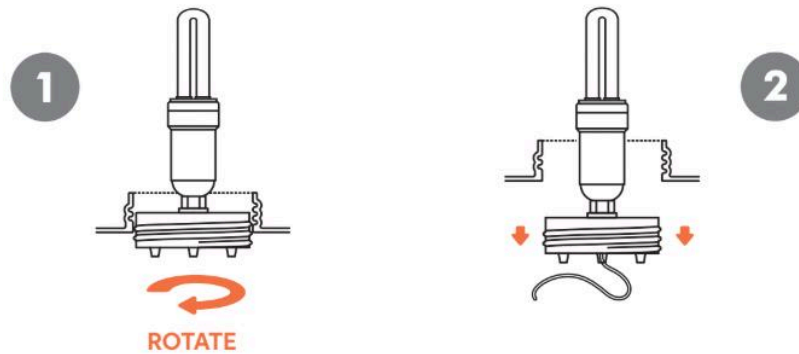

**SYSTEM FOR FLOOR/WALL MOUNTING\***

MAKE 3 HOLES AND LOCK THE  
 BASE WITH RAWLPLUGS

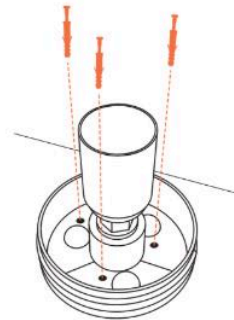

Warning: this operation could modify the degree of the waterproof protection (IP55). BULLARD BOLLARDS assumes no responsibility for any possible malfunction of the product. It is recommended to seal the holes with silicone sealant to prevent the passage of liquids.

**EARTH SPIKE POSITIONING\*\***

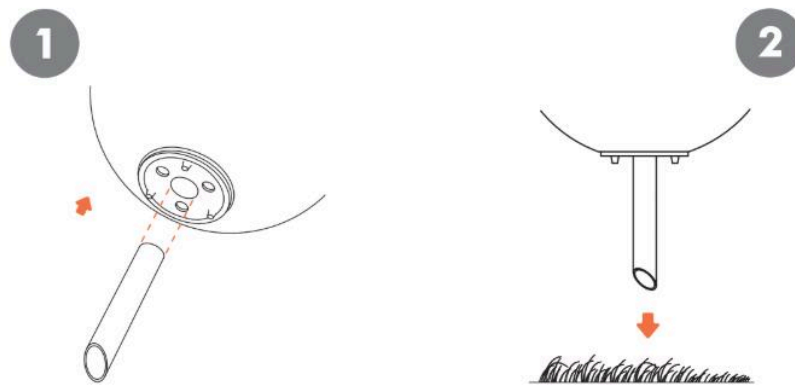

\*\* Earth spike not included. It must be ordered separately.



## CANDY LIGHT

### BLUETOOTH RGBW LED MODULE



BLUETOOTH  
TECHNOLOGY



SMARTPHONE  
OPERATED ONLY



SLIDE APP  
AVAILABLE



UP TO 250 WIRELESS  
CONNECTED LAMPS



UNLIMITED COLOURS  
AND AMBIANCES

P.2

[sales@gordonbullard.com](mailto:sales@gordonbullard.com)  
[www.bullardbollards.com](http://www.bullardbollards.com)  
1 877-964-4646



991 South Gull Lake Dr.  
Richland, MI 49083  
USA

**CANDY LIGHT MODULE PLACEMENT**

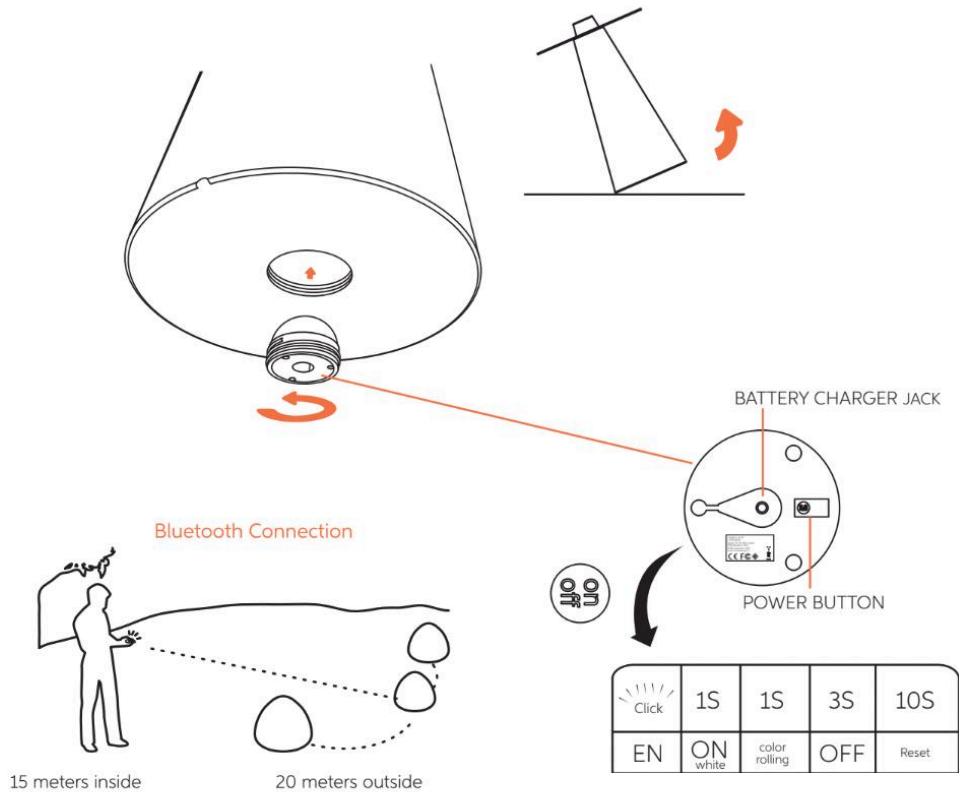

**CANDY LIGHT REMOTE CONTROL**  
**\*(SOLD SEPARATELY)**

