

**BULLARD  
SOLAR**  
One with the Sun

# COLARSUN DUAL 30 VERTICAL SOLAR STREET LIGHT

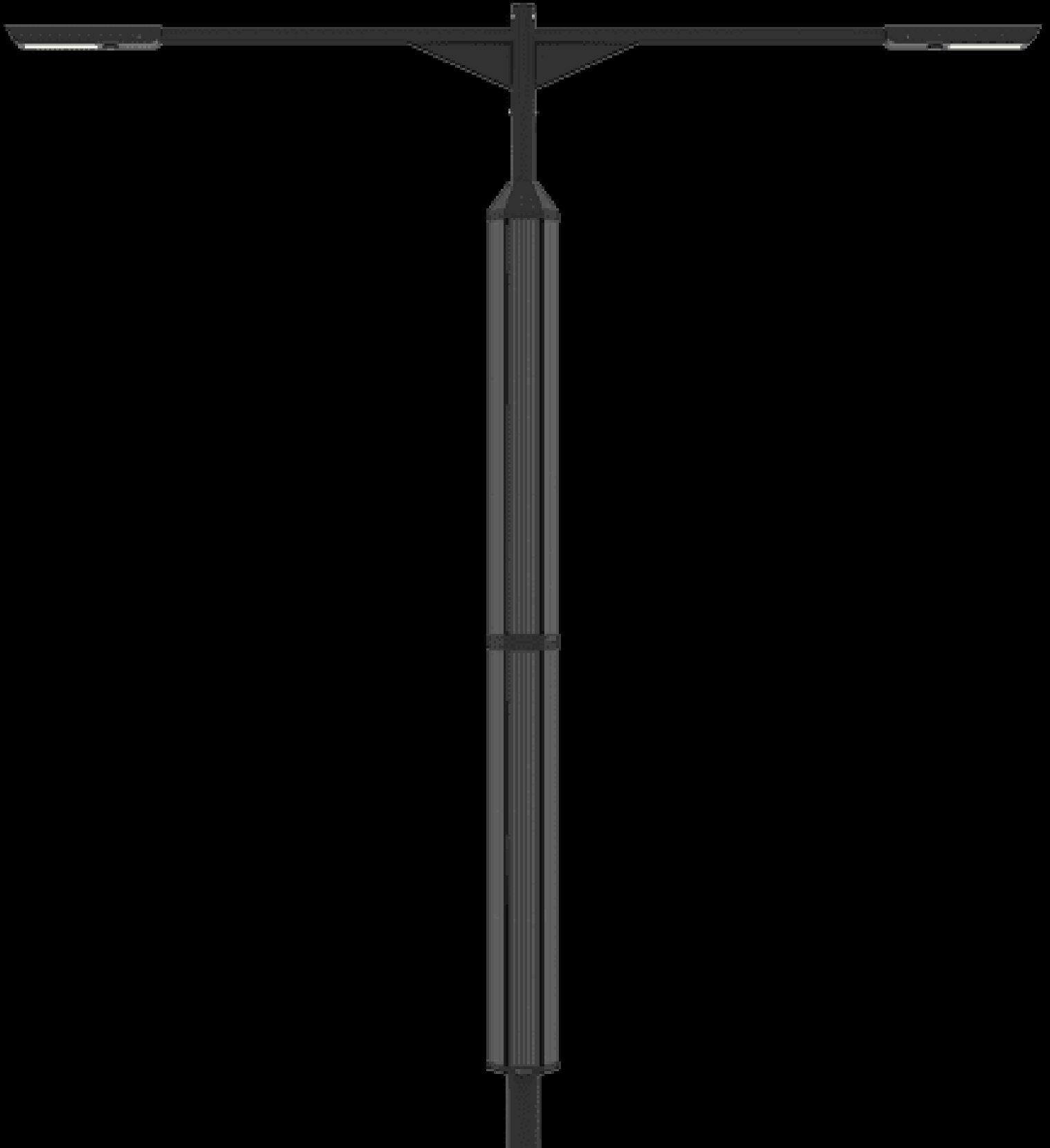

FIXTURE TYPE: \_\_\_\_\_

PROJECT NAME: \_\_\_\_\_

## INTRODUCTION

integrated solar street light



### Hello Vertical lighting,

While creating the COLARSUN we wanted a solar street light easy to install, requiring no maintenance or cleaning. Our aim was also to create a solution that could bring retrofit ting to the next level with turning existing energy consum ing and inefficient light point to sustainable solar powered at a realistic cost. After months of hard work, our team of experts developed COLARSUN solar street light, which not only meets all of these criteria, but also boasts a sleek and modern design.

### Suitable for



### Certified by

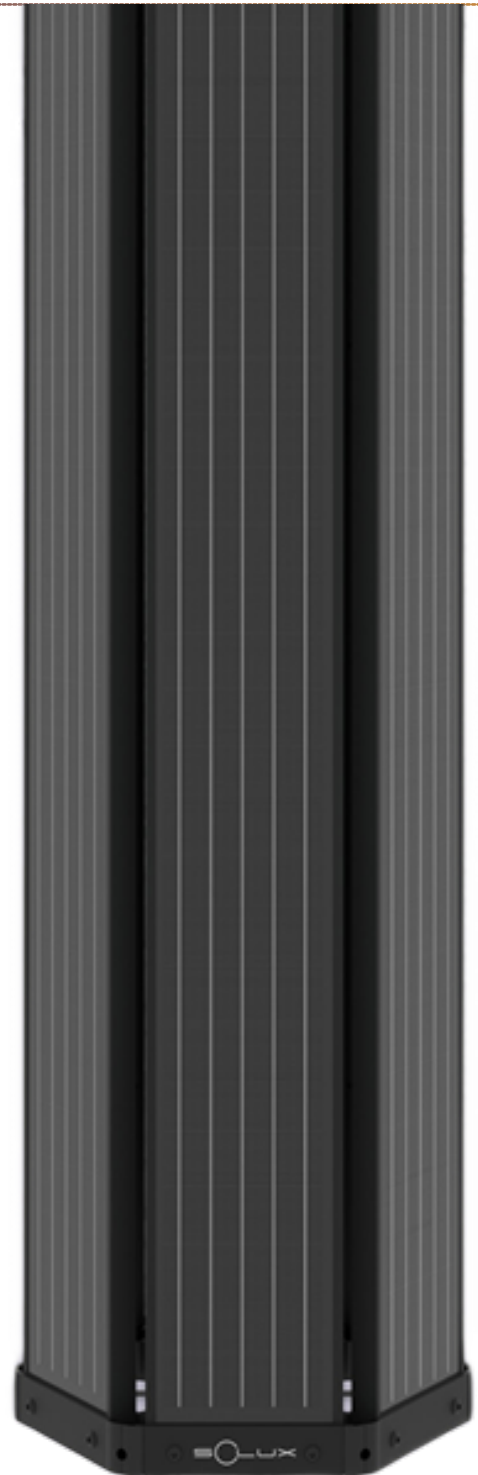

Bullard Solar retains the right to modify or change product specifications without prior notice, as part of our ongoing commitment to improvement

### ONE WITH THE SUN

sales@gordonbullard.com  
www.bullardsolar.com  
1-877-964-4646



991 South Gull Lake Dr  
Richland, MI 49083  
USA





**BULLARD  
SOLAR**  
One with the Sun

CODE:  
**BS-CS-D30-SLX**

FIXTURE TYPE: \_\_\_\_\_

PROJECT NAME: \_\_\_\_\_

**Colarsun concept**  
Easy installation - Plug & play

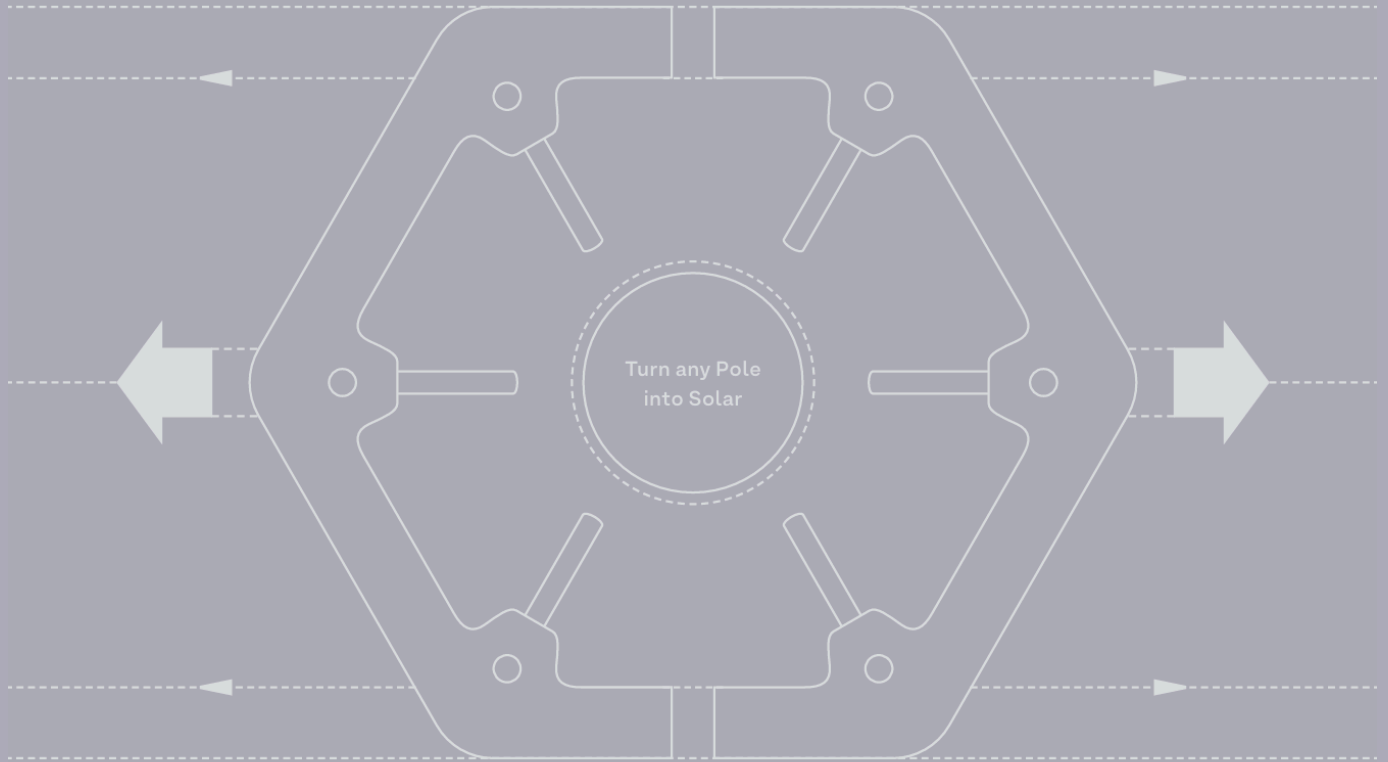

Plug & Play | One man job installation



Installation Step - 1

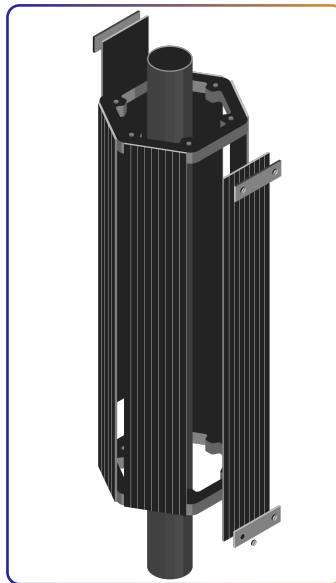

Installation Step - 2

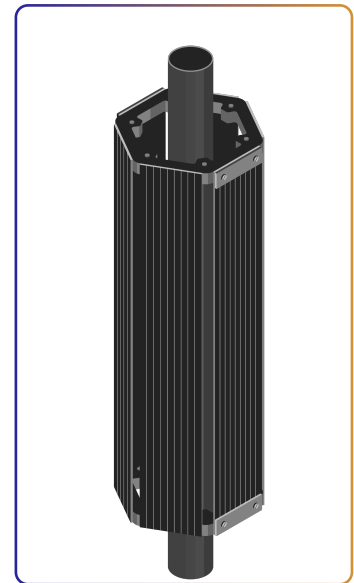

Installation Step - 2

**ONE WITH THE SUN**

sales@gordonbullard.com  
www.bullardsolar.com  
1-877-964-4646



991 South Gull Lake Dr  
Richland, MI 49083  
USA

Due to the dynamic nature of lighting products and the associated technologies, luminaire data on all specification sheets is subject to change at the discretion of Gordon Bullard LLC and associated companies.

© Bullard & Company 2024 All Rights Reserved

Updated 07/09/2024



**BULLARD  
SOLAR**  
One with the Sun

CODE:  
**BS-CS-D30-SLX**

FIXTURE TYPE: \_\_\_\_\_

PROJECT NAME: \_\_\_\_\_

## Features and advantages

### Hassle free maintenance

The unconventional vertical solar panels that ensure fewer dirt deposits and low cleaning maintenance requirements enable COLARSUN to offer the best performances consistently in any conditions. This unique and smart design makes Colarsun the perfect solution for arid desert climate.

### All in one system

Enjoy a hassle free maintenance with COLARSUN exclusive design product range.

Easy  
Access

Battery  
& Controller



Dustproof Design  
& engineering

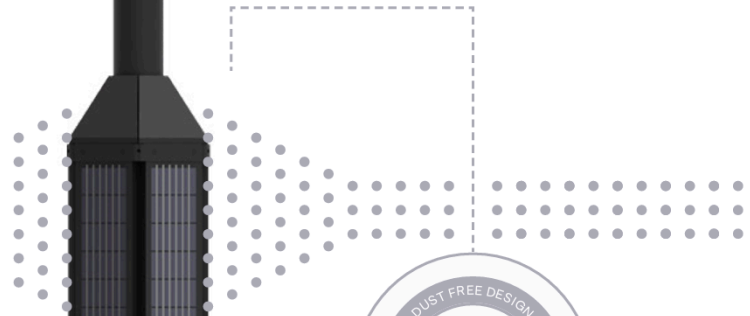

**ONE WITH THE SUN**

sales@gordonbullard.com  
www.bullardsolar.com  
1-877-964-4646



991 South Gull Lake Dr  
Richland, MI 49083  
USA

Due to the dynamic nature of lighting products and the associated technologies, luminaire data on all specification sheets is subject to change at the discretion of Gordon Bullard LLC and associated companies.

© Bullard & Company 2024 All Rights Reserved

Updated 07/09/2024



**BULLARD  
SOLAR**  
One with the Sun

CODE:  
**BS-CS-D30-SLX**

FIXTURE TYPE: \_\_\_\_\_

PROJECT NAME: \_\_\_\_\_

COLARSUN exclusive conception & design allow a sun captation at 360° all along the year maxi mizing the energy capacity of the product.

### 360° Sun Captation

Colarsun engineering is made to provide a 360° sun exposure allowing an optimum battery charging.

## FEATURE AND ADVANTAGES

360° Sun / 365 days a year



360°  
solar panels



Grade A  
Solar Cells

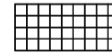

**TOPCON**  
SOLAR TECHNOLOGY ©

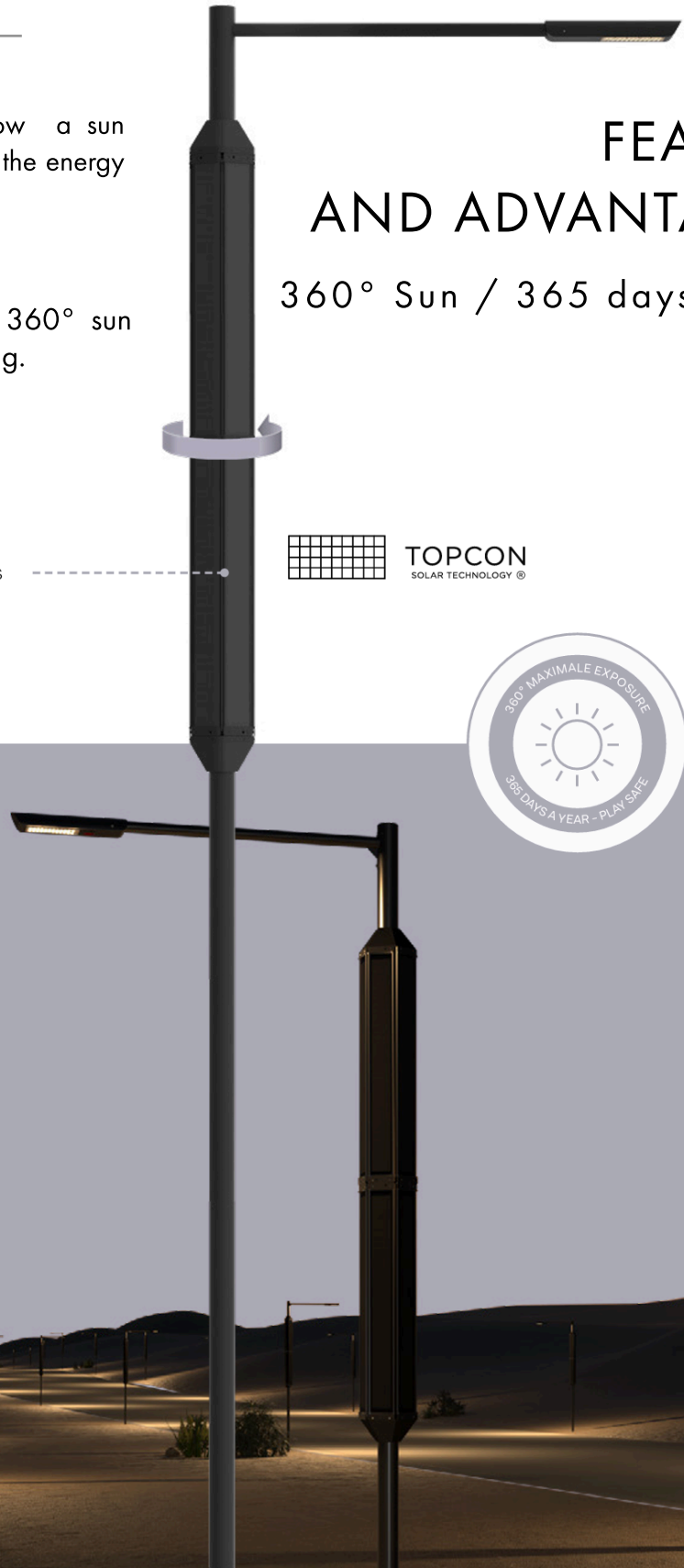
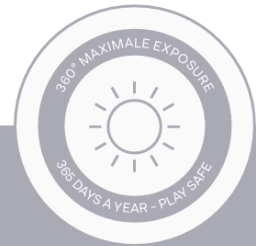

**ONE WITH THE SUN**

sales@gordonbullard.com  
www.bullardsolar.com  
1-877-964-4646



991 South Gull Lake Dr  
Richland, MI 49083  
USA

Due to the dynamic nature of lighting products and the associated technologies, luminaire data on all specification sheets is subject to change at the discretion of Gordon Bullard LLC and associated companies.

© Bullard & Company 2024 All Rights Reserved

Updated 07/09/2024



**BULLARD  
SOLAR**  
One with the Sun

CODE:  
**BS-CS-D30-SLX**

FIXTURE TYPE: \_\_\_\_\_

PROJECT NAME: \_\_\_\_\_

## LUMINAIRES HOUSING & LEDS

2 x 5880 Lumens - 2300 to 6500 K

Our luminaire boasts an anodised aluminium casing, offering exceptional protection with an IP66 rating and superior heat dissipation. Equipped with PHILIPS LUXEON HE PLUS high efficiency chips, it delivers an impressive 196 lumens per watt efficacy.

Furthermore, the luminaire adheres to DARK SKY requirements for light pollution, ensuring minimal upward lighting at just 0.31%.

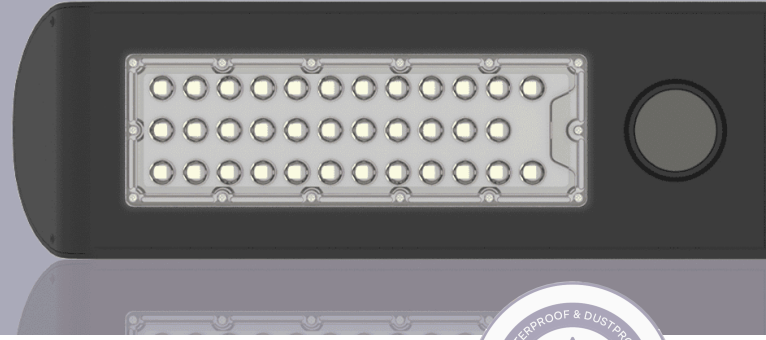

Led : 3030 | Led Q. (Pcs) : 72 | Optics: 1 | CRI > 80

**LUXEON**  
BY PHILIPS LUMILED



### DIFFERENTS OPTICS AVAILABLE

our different optics will allow you to optimize the lighting results of your projects.

(please contact us for more optics)

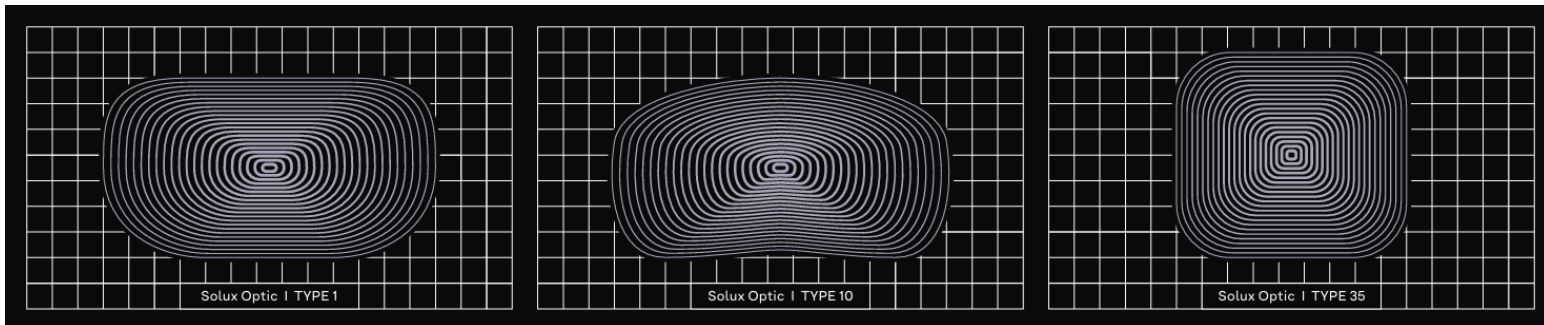

### LIGHT DISTRIBUTION CURVES

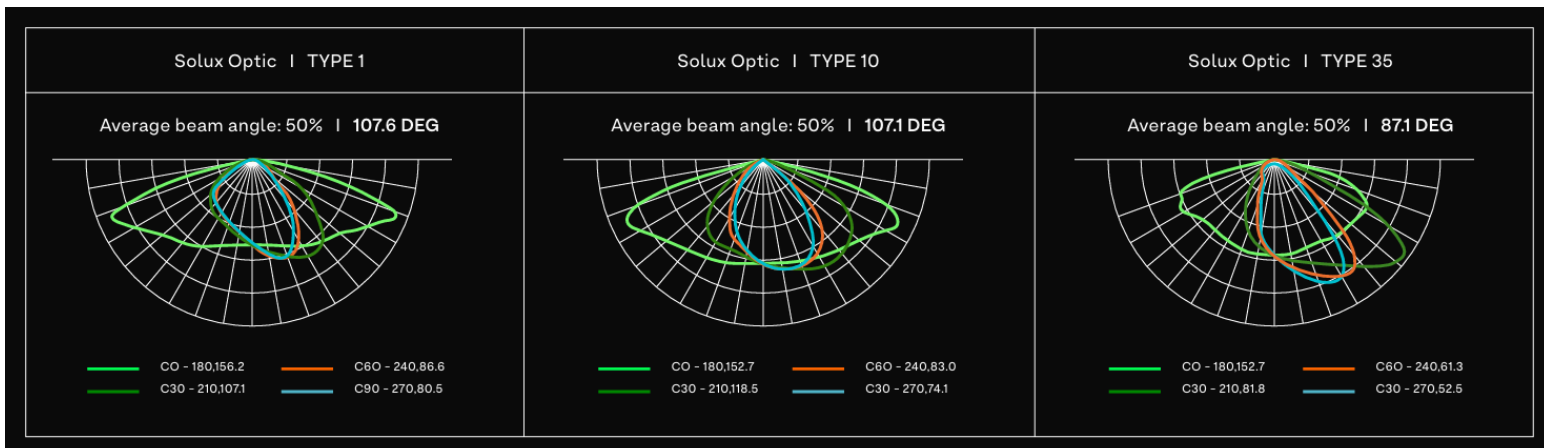

ONE WITH THE SUN

sales@gordonbullard.com  
www.bullardsolar.com  
1-877-964-4646



991 South Gull Lake Dr  
Richland, MI 49083  
USA

Due to the dynamic nature of lighting products and the associated technologies, luminaire data on all specification sheets is subject to change at the discretion of Gordon Bullard LLC and associated companies.

© Bullard & Company 2024 All Rights Reserved

Updated 07/09/2024

FIXTURE TYPE: \_\_\_\_\_

PROJECT NAME: \_\_\_\_\_

## BATTERY LIFEPO4 Made to last

### Aluminium waterproof casing & Natural Airflow

The COLARSUN series is equipped with Iron Phosphate Lithium LiFePO4 battery. This technology is proved to be the best chemical technology for solar application on the market. With a cycle life of over 5000 Cycles @ 50% DOD, the battery enjoys lifespan of over 13 years.



**Extreme conditions ready**  
-10° to 85° ( optional - 40° )

### BMS System by Bullard Solar

#### Electronic battery management system

Our batteries are equipped with electronic circuit boards for a higher protection

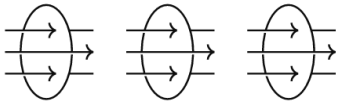

- Over & Under current - Overload
- Over & Under Voltage - Over & Under Charge
- Temperature management

DIRECT BATTERY ACCESS | ANTI THEFT SCREW 



**13.y**  
LIFETIME

High temperatures significantly impact the lifespan of batteries. To address this issue, our batteries are housed in a sealed extruded aluminum enclosure, which is renowned for its excellent heat dissipation properties. With the help of the COLARSUN Structure, natural airflow effectively regulates the temperatures of the components.



Natural Airflow design  
Lithium Life.P04 battery

## COMPARISON OF DIFFERENT BATTERY TECHNOLOGIES

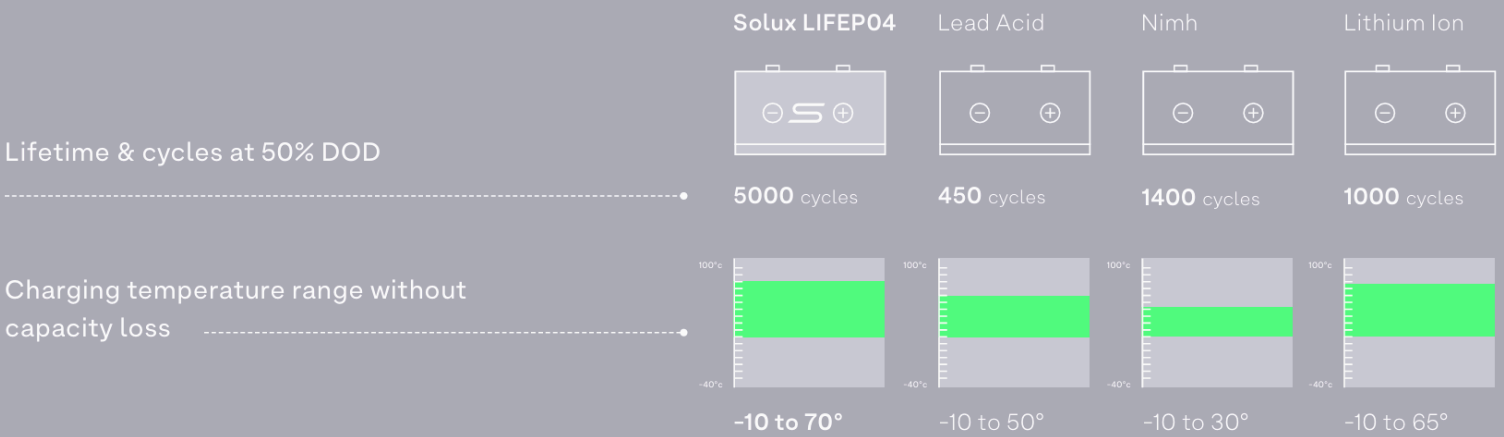

**ONE WITH THE SUN**

sales@gordonbullard.com  
www.bullardsolar.com  
1-877-964-4646



991 South Gull Lake Dr  
Richland, MI 49083  
USA

FIXTURE TYPE: \_\_\_\_\_

PROJECT NAME: \_\_\_\_\_

## TOPCON MONOCRYSTALINE SOLAR PANEL

Anodized aluminium frame for longevity

For high performance and a sleek design, the COLARSUN lights are equipped with TOPCON photovoltaic technology, providing very high efficiency, as well as improved performance in low irradiation. It allows maximizing the installed power in a limited space. Vertically mounted, they don't accumulate dust ultimately reducing the need for complex and expensive cleaning programs.

### TOPCON ADVANTAGES / POWERLOSS DUE TO SHADING

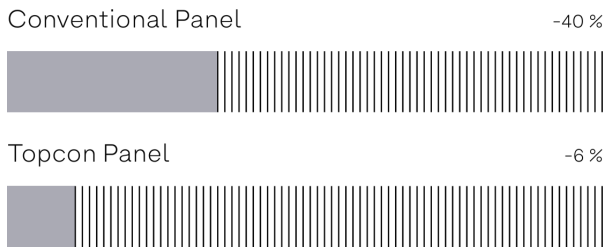

### MPPT CONTROLLER

Waterproof connectors | Performance & reliability | Up to 98% efficiency

ANTI BLACKOUT: Load adjust according to the battery capacity & Intelligent LED Driver.

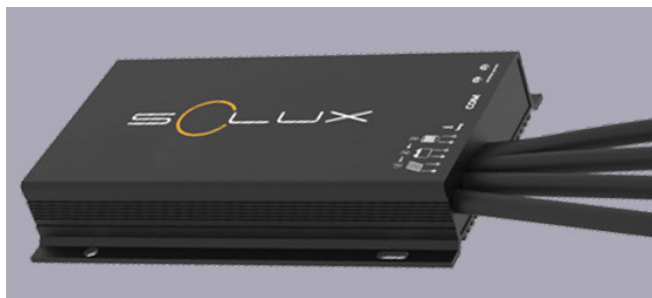

### AVAILABLE FOR HYBRID-RETROFITTING

Transform your existing street light into a solar-powered one seamlessly with our Hybrid AC/DC MPPT Controller and MEAN WELL Driver.

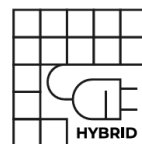

Hybrid system

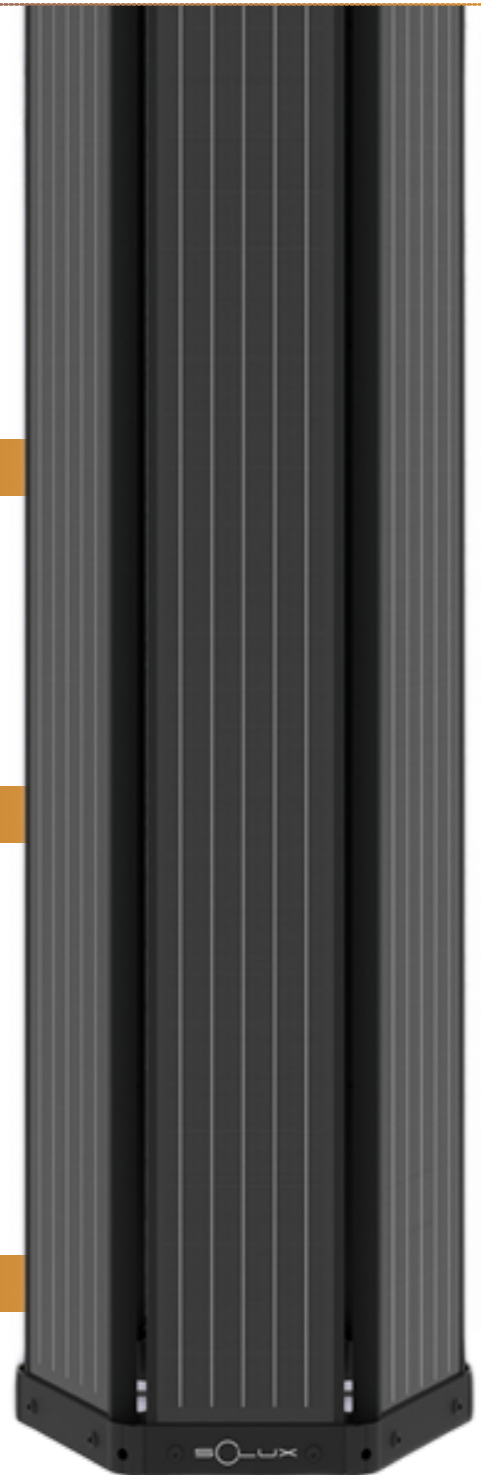

### ONE WITH THE SUN

sales@gordonbullard.com  
www.bullardsolar.com  
1-877-964-4646



991 South Gull Lake Dr  
Richland, MI 49083  
USA



**BULLARD  
SOLAR**  
One with the Sun

CODE:  
**BS-CS-D30-SLX**

FIXTURE TYPE: \_\_\_\_\_

PROJECT NAME: \_\_\_\_\_

# MICROWAVE SENSOR

Bullard Solar exclusive sensor

Bullard Solar luminaires are equipped with microwave detectors that use the Doppler effect, just like car radars, to detect nearby objects and measure their distance. The sensor emits a high-frequency wave that reflects off objects, allowing for precise analysis.

Because these microwaves only detect specific objects, our sensors offer increased detection reliability, resulting in:

- Much better reliability compared to the Infrared detector
- Up to 360° Directivity
- Insensitivity to other environmental variations such as light, color, temperature, etc.



## Presence detection

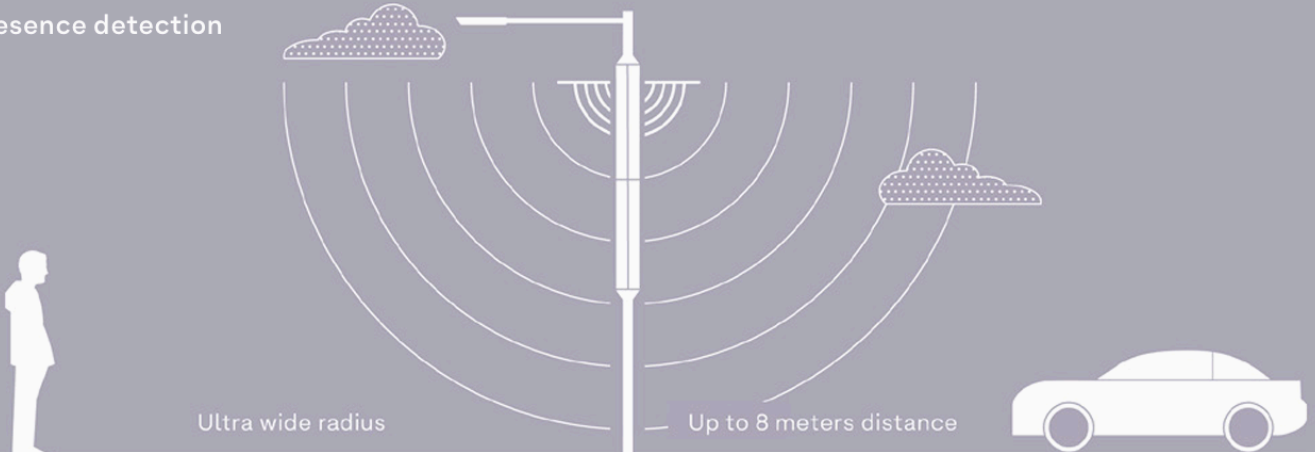

## OPERATION MODE AND LIGHTING SCHEDULE

In addition to automatic switching on and off, you can choose from different modular operating modes to suit the specific needs of your project. So, whether your project demands part-night brightness, early evening lighting, or anything in between, our flexible lighting programs have you covered!

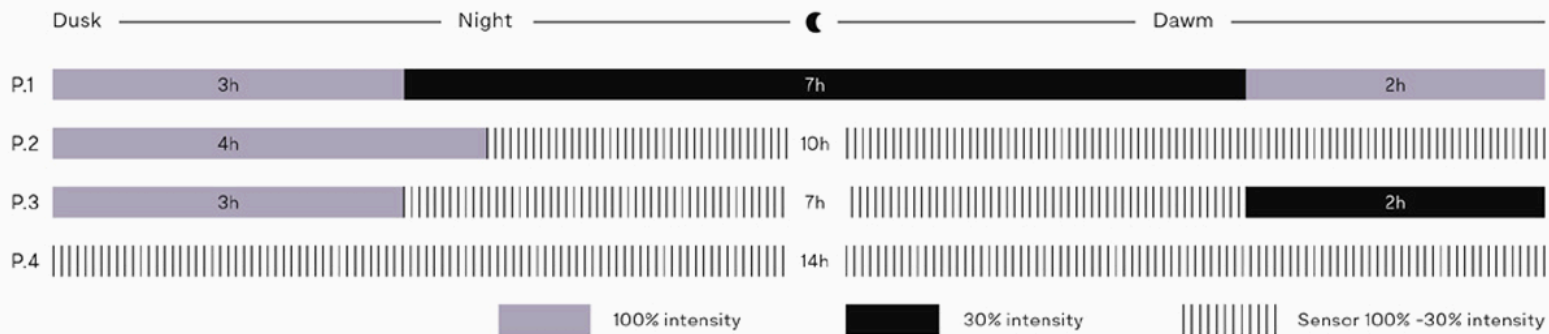

### ONE WITH THE SUN

sales@gordonbullard.com  
www.bullardsolar.com  
1-877-964-4646



991 South Gull Lake Dr  
Richland, MI 49083  
USA



FIXTURE TYPE: \_\_\_\_\_

PROJECT NAME: \_\_\_\_\_

# Technical drawing

## Colarsun Dual 30

### Product Dimensions

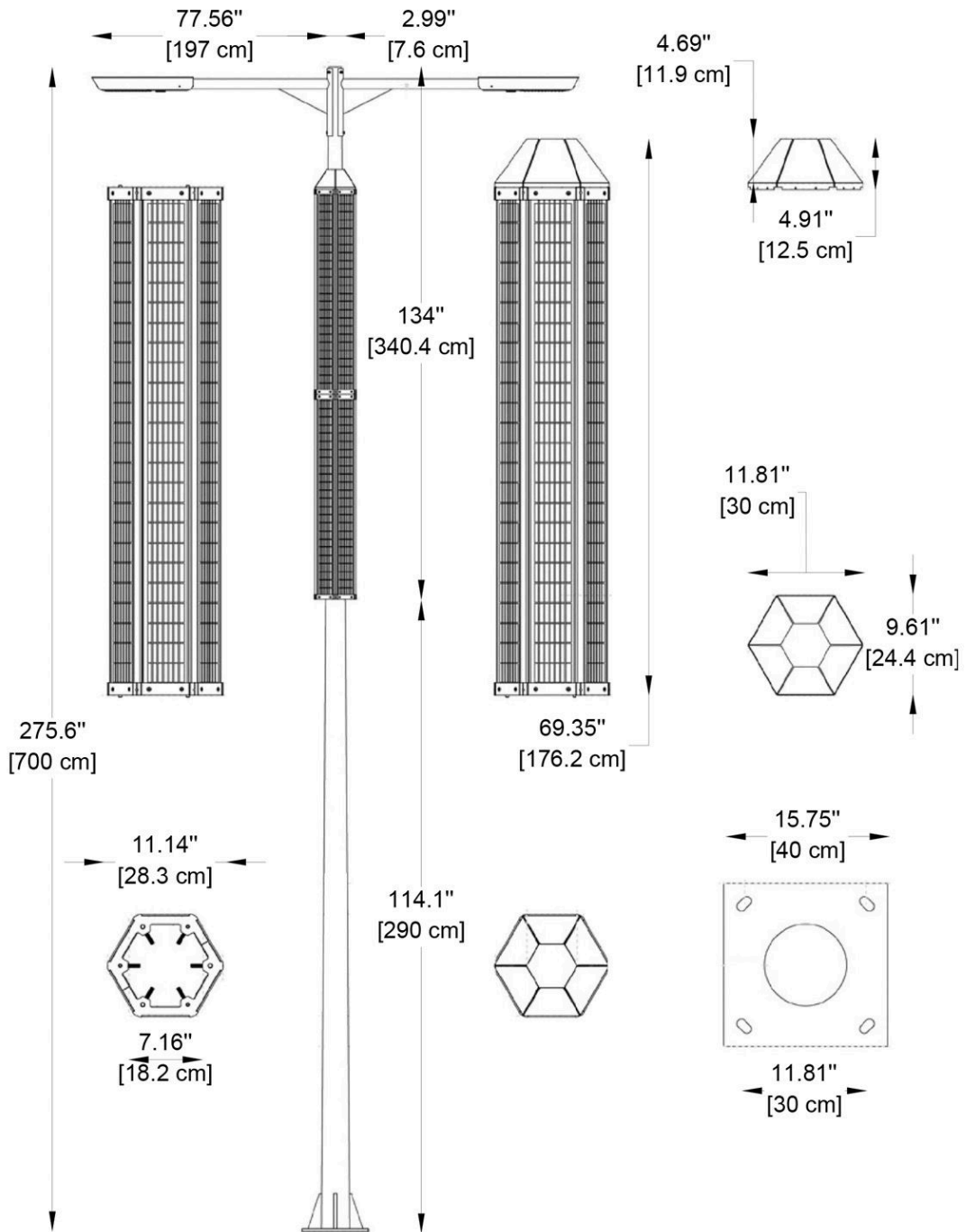

**ONE WITH THE SUN**

sales@gordonbullard.com  
www.bullardsolar.com  
1-877-964-4646



991 South Gull Lake Dr  
Richland, MI 49083  
USA



FIXTURE TYPE: \_\_\_\_\_

PROJECT NAME: \_\_\_\_\_

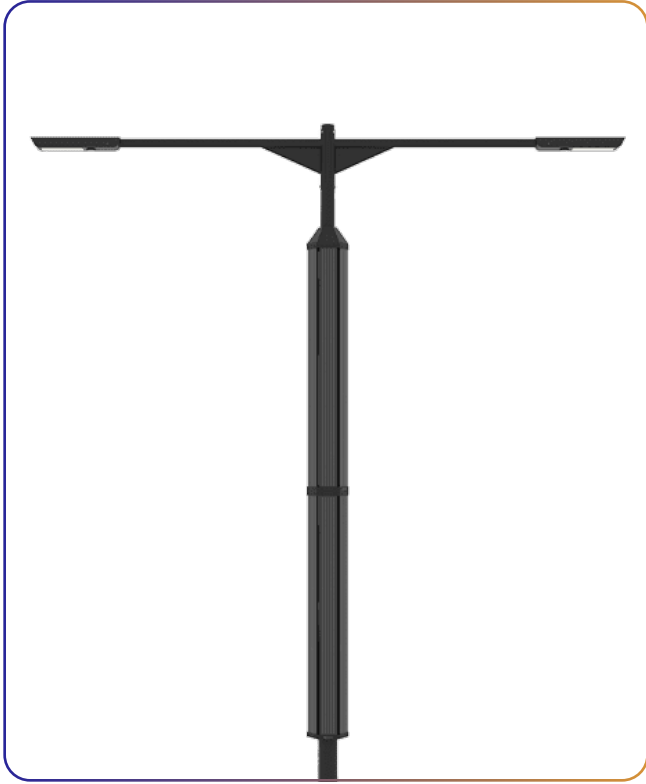

**HOW TO ORDER:**

**CODE:**

**Example:**  
CODE: BS-CS-D30-SLX-40K

BS-CS-D30-SLX-40K

**1 DIMENSIONS:**

Solar Panel - 134" (340.36 cm) x 11.14" (28.3 cm)  
x 9.92" (25.2 cm)  
Led Fixture - 0.08" (0.2 cm) x 23.62" (60 cm)  
x 6.02" (15.3 cm) x 3.19" (8.1 cm)

**2 CCT:**

-23K	2300K
-30K	3000K
-40K	4000K
-50K	5000K
-65K	6500K

**ONE WITH THE SUN**

sales@gordonbullard.com  
www.bullardsolar.com  
1-877-964-4646



991 South Gull Lake Dr  
Richland, MI 49083  
USA