

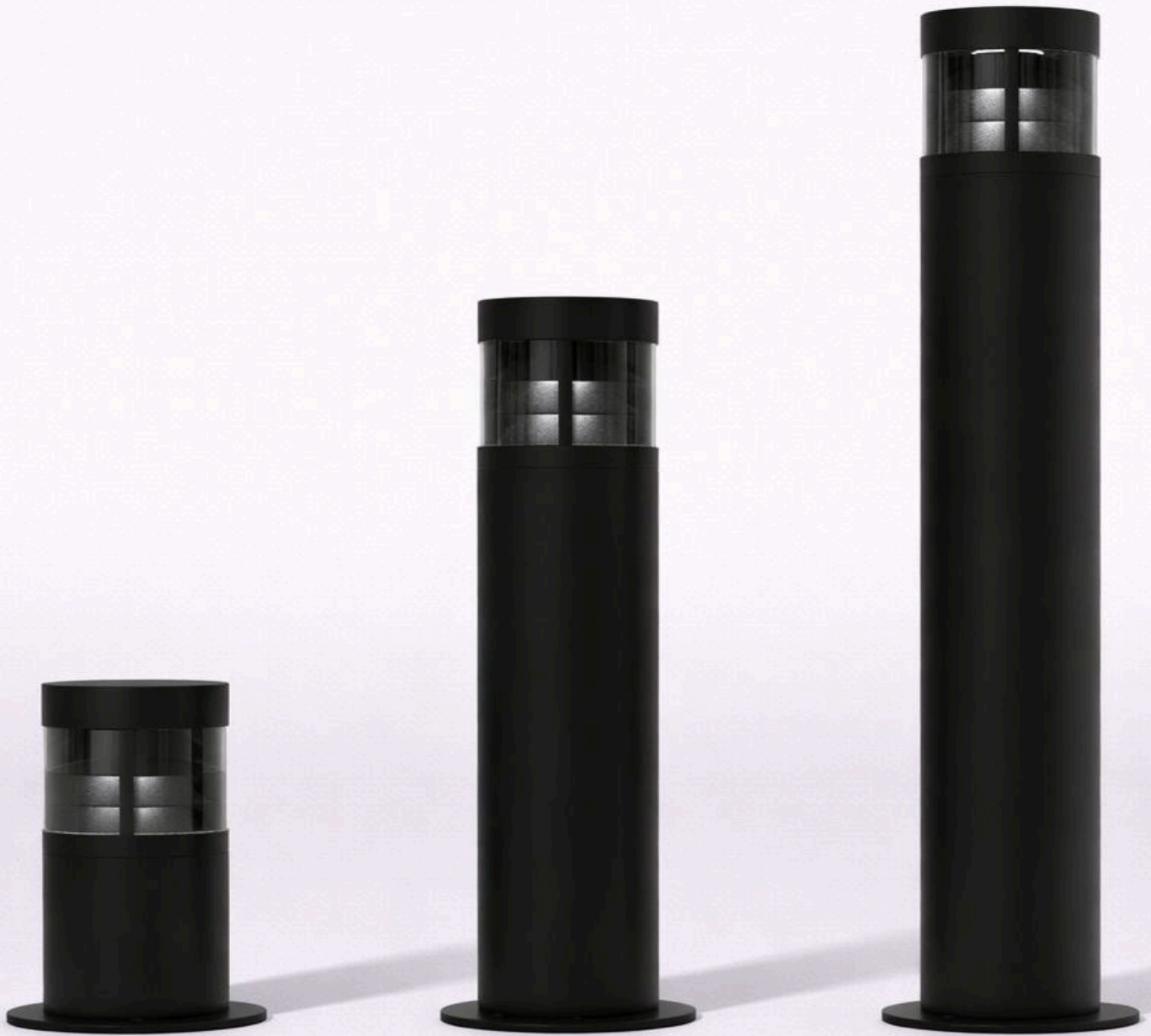

**BULLARD
BOLLARDS**
Think Bollard Think Bullard

THE ROWAN
BB-RWN-BL





**BULLARD
BOLLARDS**
Think Bollard Think Bullard

**CODE:
BB-RWN-BL**

FIXTURE TYPE: _____

PROJECT NAME: _____

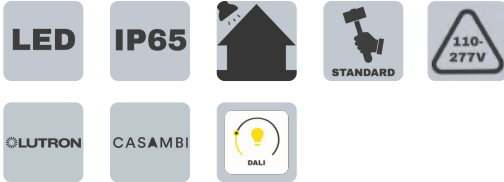

GENERAL INFORMATION:

The Rowan Bollard from Bullard Bollards is a contemporary outdoor lighting solution that combines modern aesthetics with energy efficiency. The Rowan accommodates input voltages from 110-277V, ensuring versatility across various settings. Available in three sizes to suit different design preferences: 11.81" (30 cm), 21.65" (55 cm), 31.49" (80 cm) Each bollard is constructed from die-cast, powder-coated aluminum, ensuring both durability and a sleek appearance. Finish options include Sanded Black, Light Sanded Grey, and Dark Grey, allowing for seamless integration into various architectural styles.

FIXTURE TYPE:

Bollard

VOLTAGE:

110-277V



MATERIAL:

Die-casting powder coated aluminum.

IP RATING:

IP65



LENS:

PMMA

WARRANTY:

LED lighting products are warranted for 5 years.

MAIN FEATURES:

- High visual comfort
- Available in a wide range of finishes
- Functional and minimalistic design
- Shock-resistant construction
- Operating Temperature: -104°F to +140°F.

LIGHTING DISTRIBUTIONS:

360°

THINK BOLLARD - THINK BULLARD

sales@gordonbullard.com
www.bullardbollards.com
1-877-964-4646



991 South Gull Lake Dr
Richland, MI 49083
USA



FIXTURE TYPE: _____

PROJECT NAME: _____

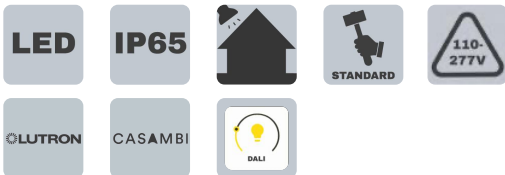
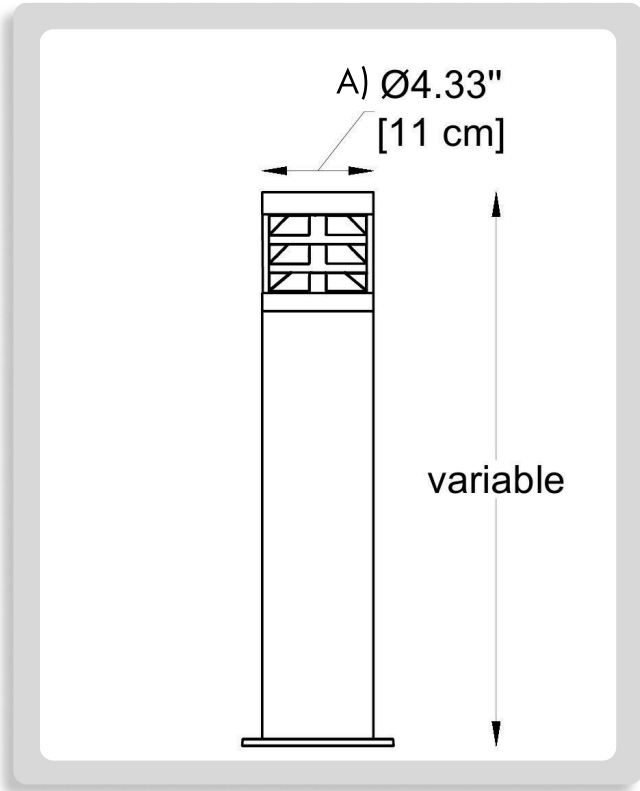

HOW TO ORDER:

CODE:

Example:
CODE:
BB-RWN-BL-H1-30K-DIM-SB-JC3001

BB-RWN-BL-
H1-30K-DIM-SB-
JC3001

1 BODY HEIGHT:

- H1 H: 11.81" (30 cm)
- H2 H: 21.65" (55 cm)
- H3 H: 31.49" (80 cm)

2 DIAMETERS:

A) Ø1: 4.33" (11 cm)

3 LIGHT SOURCE:

LED / 6.7W / 95 mA / 79 lm / 80 CRI





4 CCT:

- 30K 3000K
- 40K 4000K
- 50K 5000K
- CUS Custom on request

5 DIMMING OPTIONS:

- NON NON-Dimmable
- DIM 0-10V
- CAS Casambi
- LUT Lutron
- DAL Dali

6 FINISH OPTIONS:

- SB Sanded Black (RAL 9005) 
- DG Sanded Dark Grey (Kap 7037) 
- LSG Sanded Bronze (KAP 7008) 
- CUS Custom on request* 

THINK BOLLARD - THINK BULLARD

sales@gordonbullard.com
www.bullardbollards.com
1-877-964-4646



991 South Gull Lake Dr
Richland, MI 49083
USA



FIXTURE TYPE: _____

PROJECT NAME: _____

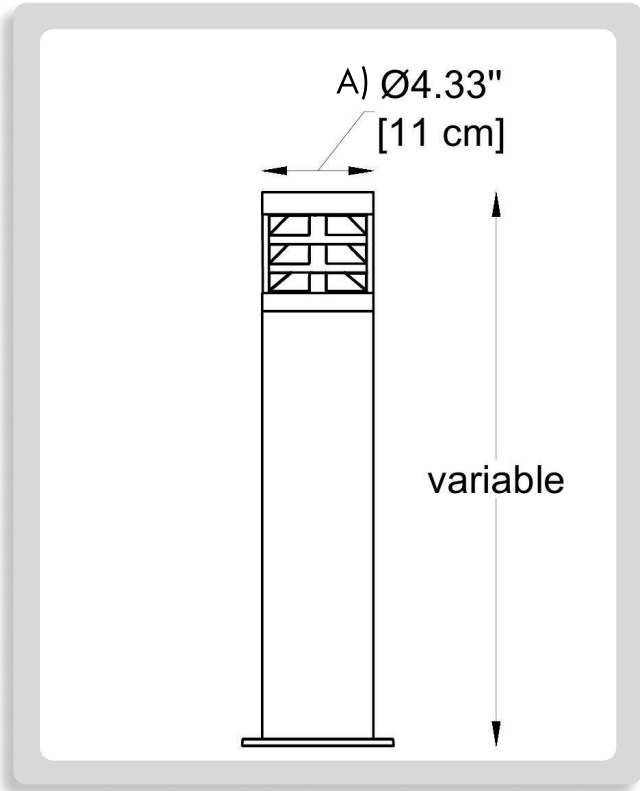

HOW TO ORDER:

CODE:

Example:
CODE:
BB-RWN-BL-H1-30K-DIM-SB-JC3001

BB-RWN-BL-
H1-30K-DIM-SB-
JC3001

7 INSTALLATION BASE:

Flange Base
(included)

Ø: 5.91" (15 cm)

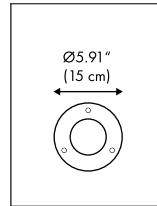
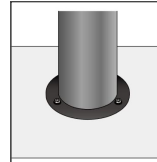

Inground Base
(option)

Code: **-JC3001**



L: 10.16" (25.8 cm)
H: 8.27" (21 cm)
Ø 1: 6.30" (16 cm)
Ø 2: 3.54" (9 cm)

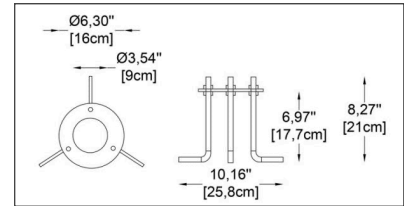

*Flange base is a basic part
you need to assemble
the landing base.

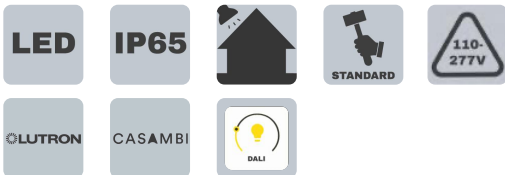

THINK BOLLARD - THINK BULLARD

sales@gordonbullard.com
www.bullardbollards.com
1-877-964-4646



991 South Gull Lake Dr
Richland, MI 49083
USA

FIXTURE TYPE: _____

PROJECT NAME: _____

HOW TO ORDER:

CODE:

**Example:
CODE:
BB-RWN-BL-H1-30K-DIM-SB-JC3001**

**BB-RWN-BL-
H1-30K-DIM-SB-
JC3001**

PHOTOMETRICS:

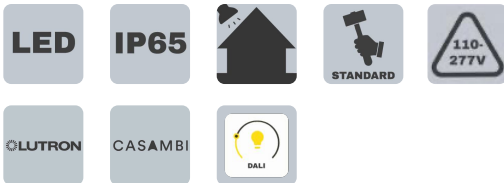
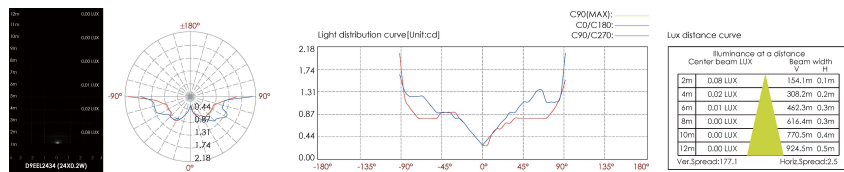

THINK BOLLARD - THINK BULLARD

sales@gordonbullard.com
www.bullardbollards.com
1-877-964-4646



991 South Gull Lake Dr
Richland, MI 49083
USA