

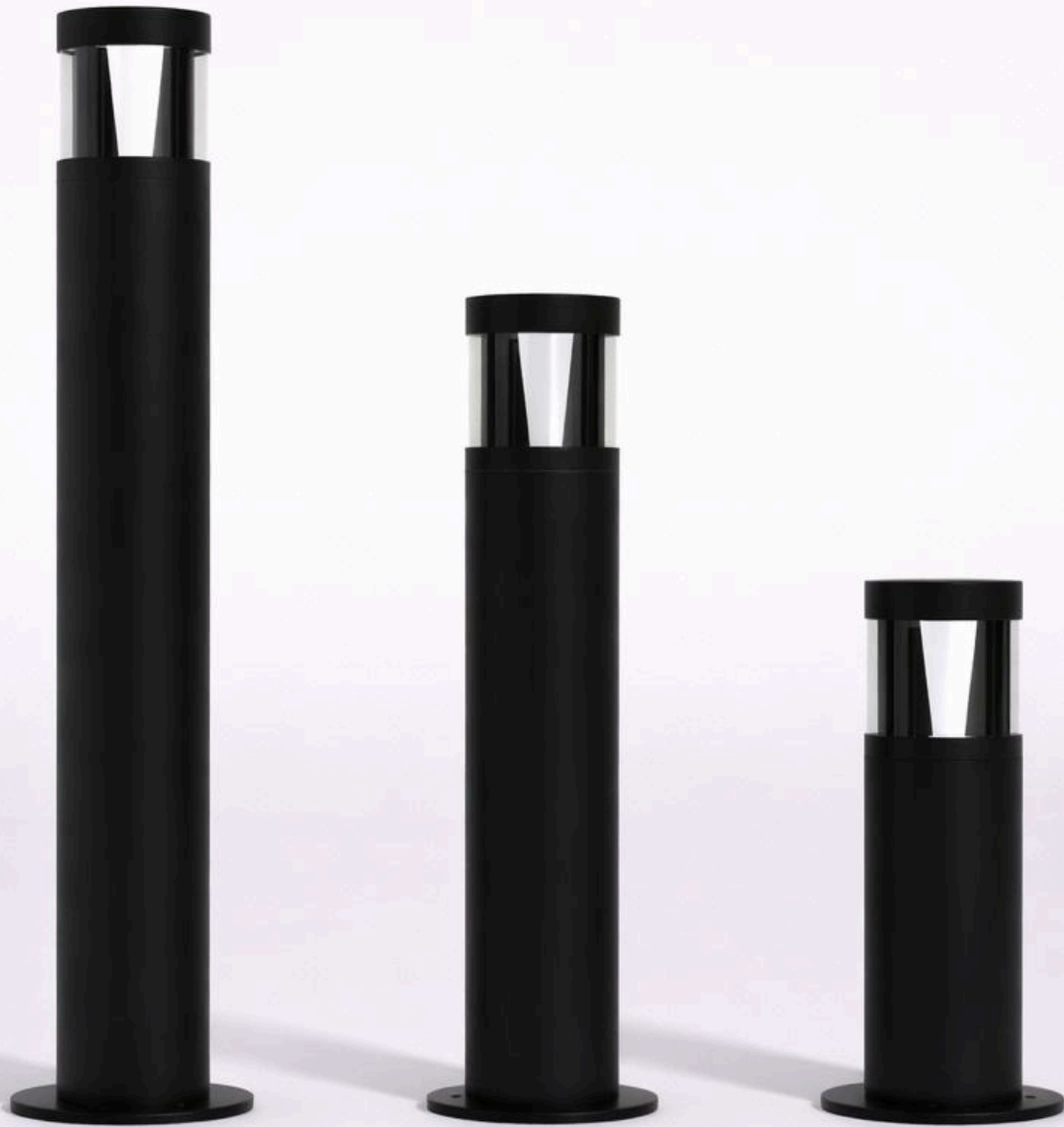

**BULLARD
BOLLARDS**
Think Bollard Think Bullard

THE CEDRO
BB-CDR-BL





FIXTURE TYPE: _____

PROJECT NAME: _____

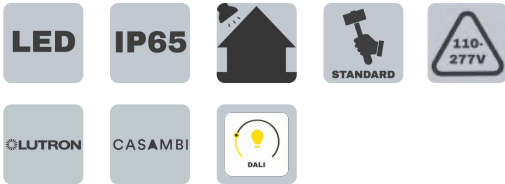

GENERAL INFORMATION:

The Cedro is a sleek and durable bollard from Bullard Bollard, designed to deliver reliable outdoor illumination with modern aesthetics. Constructed from corrosion-resistant aluminum or stainless steel, The Cedro features a high-quality powder-coated finish, ensuring it withstands harsh outdoor conditions. Available in various heights (11.81" 30 cm, (21.65") 55 cm, and 31.49" (80 cm), this bollard is equipped with energy-efficient LED technology, offering color temperature options of 2700K, 3000K, 4000K, or 5000K.

FIXTURE TYPE:

Bollard

VOLTAGE:

110-277V



MATERIAL:

Die-casting powder coated aluminum.

IP RATING:

IP65



LENS:

PMMA

WARRANTY:

LED lighting products are warranted for 5 years.

DRIVER POSITION:

Remote

MAIN FEATURES:

- High visual comfort
- Available in a wide range of finishes
- Functional and minimalistic design
- Shock-resistant construction
- Operating Temperature: -104°F to +140°F.

LIGHTING DISTRIBUTIONS:

360°

THINK BOLLARD - THINK BULLARD

sales@gordonbullard.com
www.bullardbollards.com
1-877-964-4646



991 South Gull Lake Dr
Richland, MI 49083
USA



FIXTURE TYPE: _____

PROJECT NAME: _____

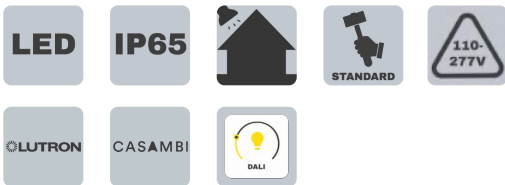
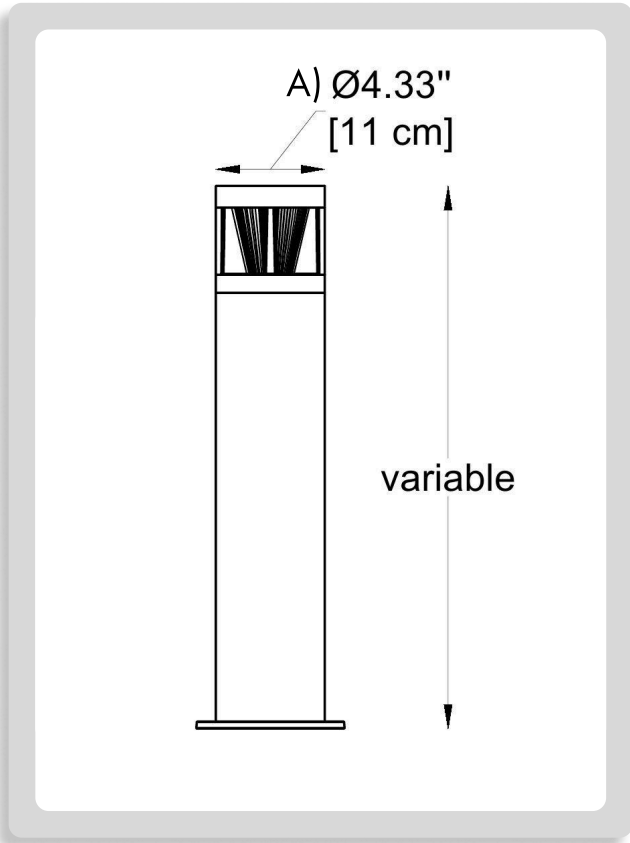

HOW TO ORDER:

CODE:

Example: CODE: BB-CDR-BL-H2-30K-DIM-SB-JC3001	BB-CDR-BL- H2-30K-DIM-SB- JC3001
---	--

1	BODY HEIGHT:	
----------	---------------------	--

- H1 H: 11.81" (30 cm)
- H2 H: 21.65" (55 cm)
- H3 H: 31.49" (80 cm)

2	DIAMETER:	
----------	------------------	--

A) Ø1: 4.33" (11 cm)

3	LIGHT SOURCE:	
----------	----------------------	--

LED / 6.7W / 95 mA / 264.5 lm / 80 CRI





4	CCT:	
----------	-------------	--

- 30K 3000K
- 40K 4000K
- 50K 5000K
- CUS Custom on request

5	DIMMING OPTIONS:	
----------	-------------------------	--

- NON NON-Dimmable
- DIM 0-10V
- CAS Casambi
- LUT Lutron
- DAL Dali

6	FINISH OPTIONS:	
----------	------------------------	--

- SB Sanded Black (RAL 9005) 
- DG Sanded Dark Grey (Kap 7037) 
- LSG Sanded Bronze (KAP 7008) 
- CUS Custom on request* 

THINK BOLLARD - THINK BULLARD

sales@gordonbullard.com
www.bullardbollards.com
1-877-964-4646



991 South Gull Lake Dr
Richland, MI 49083
USA



FIXTURE TYPE: _____

PROJECT NAME: _____

HOW TO ORDER:

CODE:

Example:
CODE:
BB-CDR-BL-H2-30K-DIM-SB-JC3001

BB-CDR-BL-
H2-30K-DIM-SB-
JC3001

7 INSTALLATION BASE:

Flange Base
(included)*

Ø: 5.91" (15 cm)

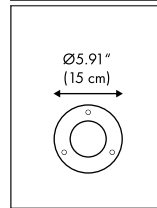
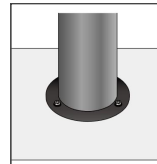

Inground Base
(option)

Code: **-JC3001**



L: 10.16" (25.8 cm)
H: 8.27" (21 cm)
Ø 1: 6.30" (16 cm)
Ø 2: 3.54" (9 cm)

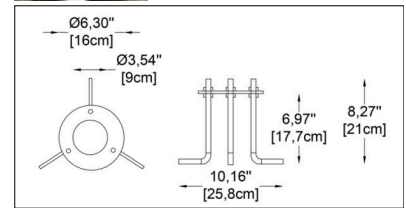

*Flange base is a basic part
you need to assemble
the landing base.

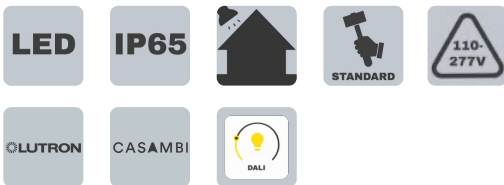
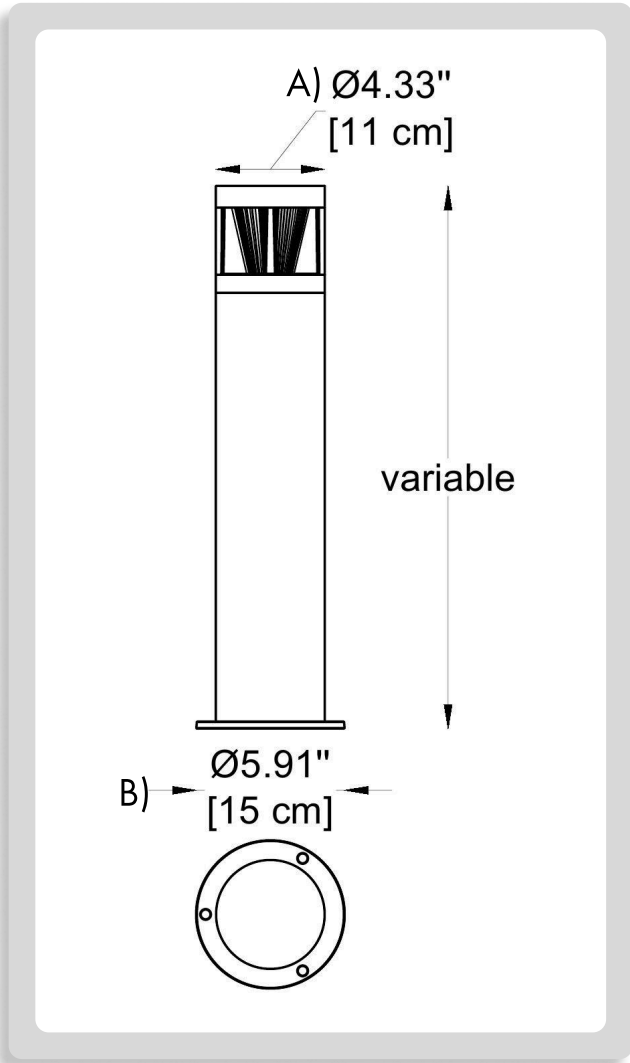

THINK BOLLARD - THINK BULLARD

sales@gordonbullard.com
www.bullardbollards.com
1-877-964-4646



991 South Gull Lake Dr
Richland, MI 49083
USA



**BULLARD
BOLLARDS**
Think Bollard Think Bullard

**CODE:
BB-CDR-BL**

FIXTURE TYPE: _____

PROJECT NAME: _____

HOW TO ORDER:

CODE:

Example:
CODE:
BB-CDR-BL-H2-30K-DIM-SB-JC3001

BB-CDR-BL-
H2-30K-DIM-SB-
JC3001



PHOTOMETRICS:

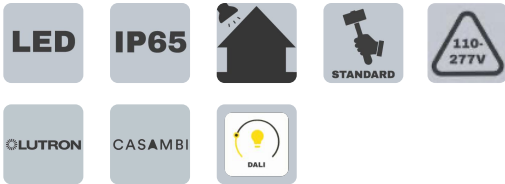
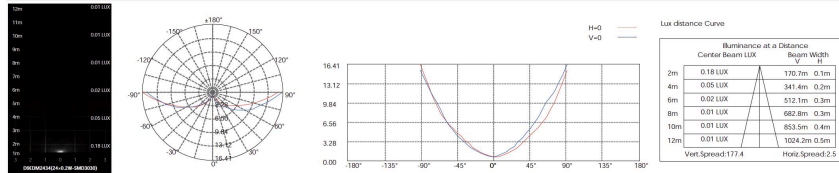

THINK BOLLARD - THINK BULLARD

sales@gordonbullard.com
www.bullardbollards.com
1-877-964-4646



991 South Gull Lake Dr
Richland, MI 49083
USA